

in YouTube Instagram Facebook  
#tankspecialist

# TANK it EASY



brochure/catalogue

 **Padoan**<sup>®</sup>

WETANKYOU SINCE 1937

# Our Identity

## VISION

We aim to provide the best solutions for applications and industrial vehicles that in turn create value and improve people's lives.

Together we build the future.

## MISSION

We design and supply solutions for industrial vehicles and machinery with tanks (oil, diesel and combined) and accessories, providing expertise and support right from the planning stage.

As #tankspecialist we identify the best choice for the specific application.

## WETANKYOU since 1937.

Family company since 1937, we are a prime manufacturer of oil, diesel and combined tanks for industrial vehicles and machinery.

Our strong focus on R&D, innovation, technology and support to our customers is translated into action by PADOAN GROUP.

We develop our solutions working side by side with our customers who mainly are bodybuilders, OEMs and distribution networks in more than 50 Countries worldwide.

The Italian design and quality mark out our wide range of tanks that is divided in "N" (the standard and multipurpose line) and "X", tanks which are designed and customized according to the customer and application needs.

We look forward to supporting you in reaching your goals.

## TANK it easy

Padoan's identity is unique, as a TANKSPECIALIST, and at the same time it is marked by multiple facets that, individually and as a globality, aim to represent added value for those who rely on Padoan to achieve their goals.

The added value can be found in one word: **SOLUTION**.

The world of industrial vehicles and machinery is a complex field, characterised by a plurality of processes, even in procurement.

That is why the services and daily activities ensured by Padoan aim to represent a **plus** that joins the **experience** and **specialisation** on tanks for industrial vehicles and machinery, developed in **more than 85 years of activity**.

Padoan aims to be a partner that takes care of every detail, making your business and professional life easier.

In a few words: **TANK it easy**.

Go to the configurator



[www.padoan.it/en/configurator/](http://www.padoan.it/en/configurator/)

Go to the virtual showroom



[www.padoan.it/en/virtual-showroom/](http://www.padoan.it/en/virtual-showroom/)

Visit Padoan website



[www.padoan.it](http://www.padoan.it)

# TANK it EASY





### The ANSWER to your project

is at hand thanks to our segmentation. Give us the details of your application or project and we will provide you with the most suitable solution thanks to our expertise.



### Value in SUSTAINABILITY

thanks to the certification that can enhance your brand and positioning. ISO14001 is on its way.

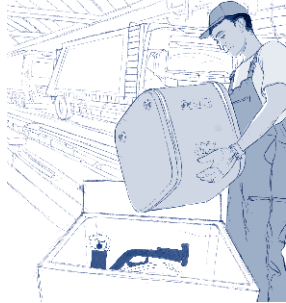

### ONE-STOP supply

for filters, indicators, fittings, ball valves, and much more. Everything you require is included in one pack, already assembled, if needed. A plug&play solution that you can simply unpack and install.



### Value in PROCESSES

with smooth procedures management also granted by ISO9001.



### The whole solution in JUST ONE CODE

since the product reference can include the mounting kit making the order process and warehouse management easier.



### Caring for YOUR IDENTITY

because your uniqueness and identity really matter to us. Customization can be the answer.



### Smart PROCUREMENT

thanks to a dedicated strategy of production planning with experts monitoring statistical trends.



### SUPPLY CHAIN valorisation

because our supplier partners represent a value to share with you to reach your goals.

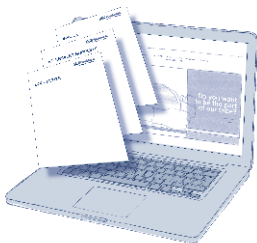

### Easy MANAGEMENT

for your aftersales requests. Outstanding quality merges with ultimate support through the portal available on your smartphone.



### Home DELIVERY opportunity

thanks to transport managed by our specialized team.



### A special TEAM

of people who are truly involved in your goals and ready to give you the best pre- and post-sales opportunities.

**FOR INDUSTRIAL/  
COMMERCIAL VEHICLES  
AND MACHINERY**

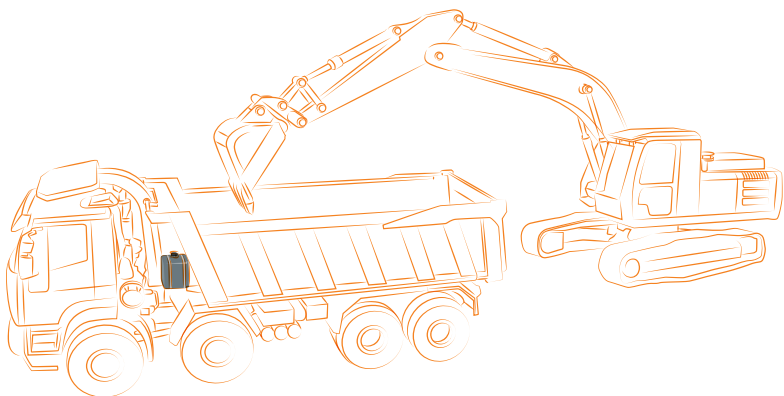
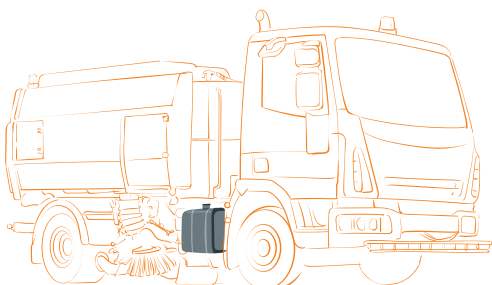
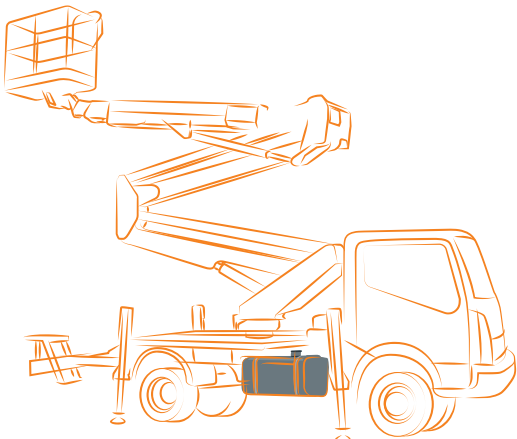
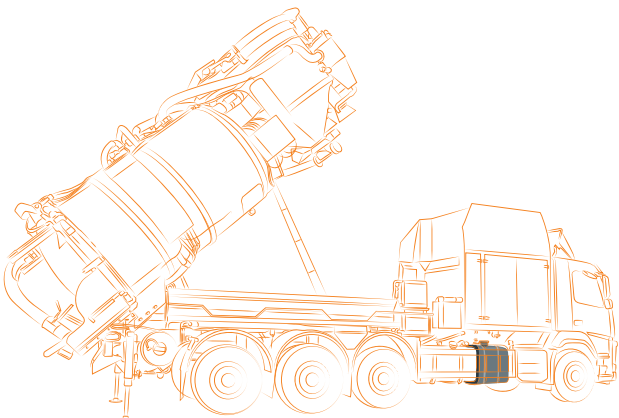
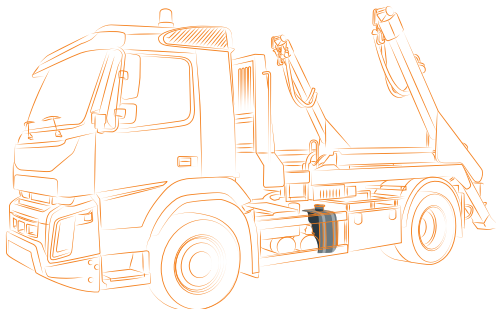
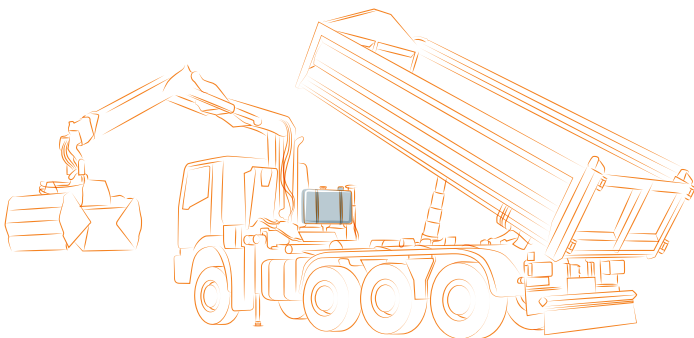
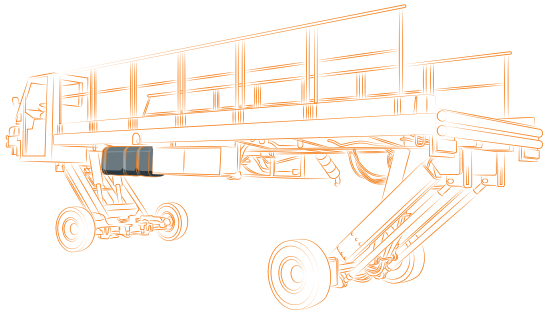
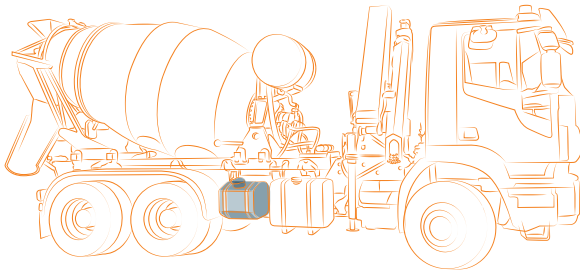

**TANK  
SPECIALIST**

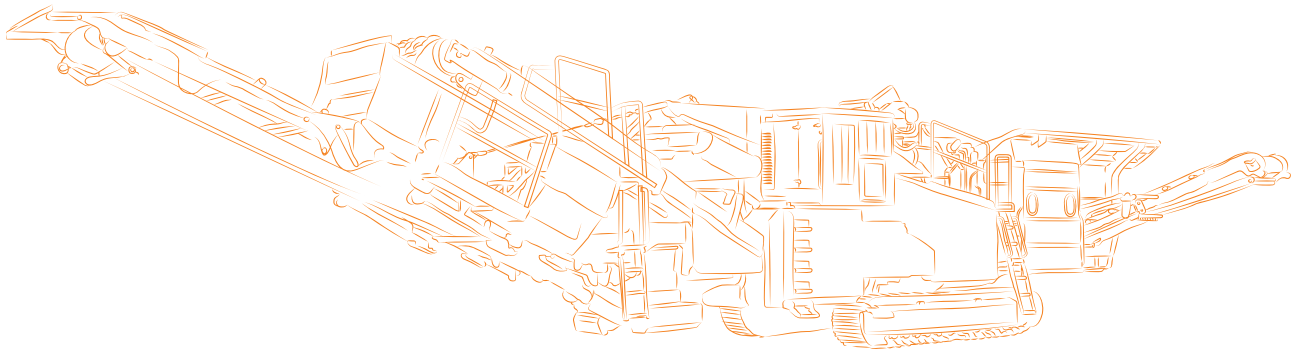
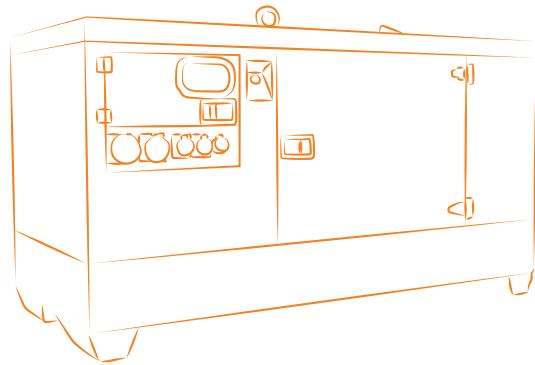
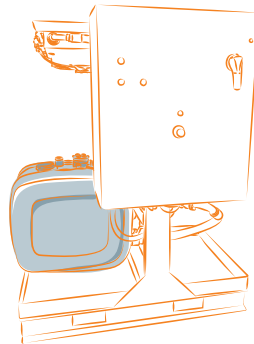
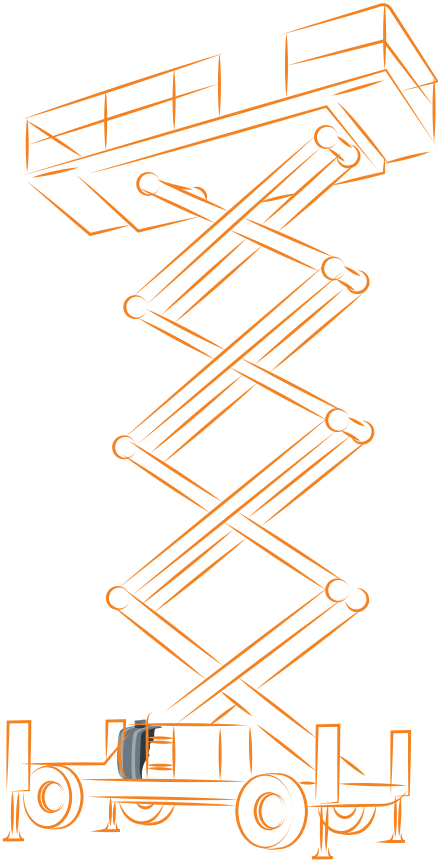
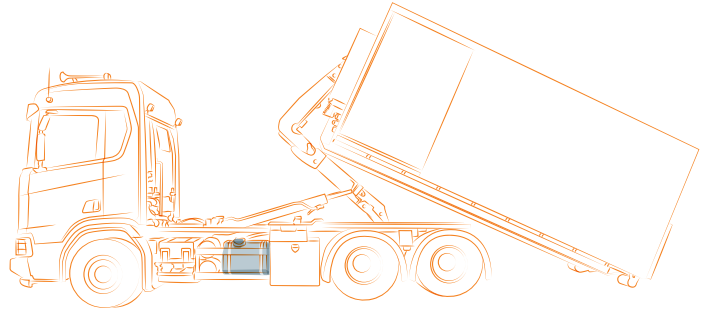
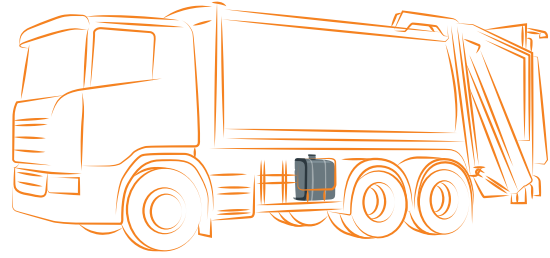
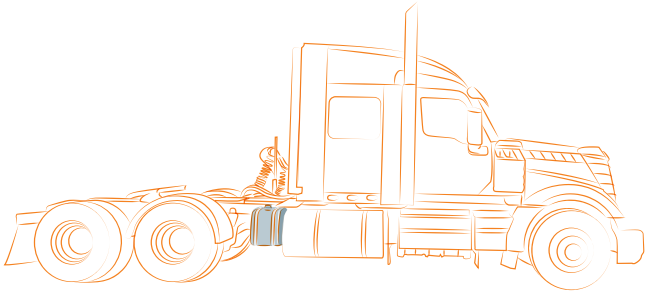

# PRODUCTS CATALOGUE

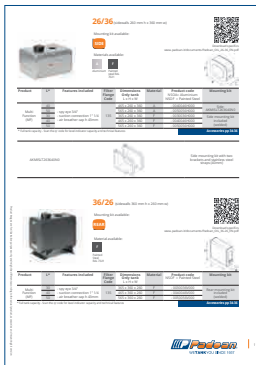

The complete product code is composed by the material code and the product code listed in the table for each item.  
(example: NSOA0070035MF00)

Download the technical sheet with details

For dimensions with mounting kit, please refer to the technical sheet you can download by scanning the QR Code



**26/36** (sidewalls 260 mm h x 360 mm w)

Mounting kit available:

**SIDE**

Materials available:

**A** Aluminium  
**F** Painted steel RAL 7021



Download specifics  
[www.padoan.it/documents/Padoan\\_OIL\\_26-36\\_EN.pdf](http://www.padoan.it/documents/Padoan_OIL_26-36_EN.pdf)

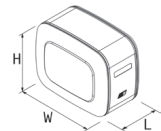

Code of filter flange that couples with Padoan filters

Product	L*	Features included	Filter Flange Code	Dimensions Only tank L x H x W	Material	Product code NSOA= Aluminium NSOF = Painted Steel	Mounting kit
Multi Function (MF)	40	- spy eye 3/4" - suction connection 1" 1/4 - air breather cap h 43mm	135	465 x 260 x 360	A	- 0040046H000	Side: AKMISLT263640N0
	50			565 x 260 x 360	A	- 0050056H000	
	30			365 x 260 x 360	F	- 0030036H000	Side mounting kit included (welded)
	40			465 x 260 x 360	F	- 0040046H000	
	50			565 x 260 x 360	F	- 0050056H000	

\* Full tank capacity - Scan the qr code for level indicator capacity and technical features

Accessories pp 34-36

AKMISLT263640N0

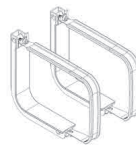

Side mounting kit with two brackets and stainless steel straps (40mm)

Code for the specific mounting kit

## SEGMENTATION

Get in touch with Padoan team and fill out the form to send us the details of your system so that you can receive the technical solution most adapt to your requirements.

[www.padoan.it/segmentation](http://www.padoan.it/segmentation)

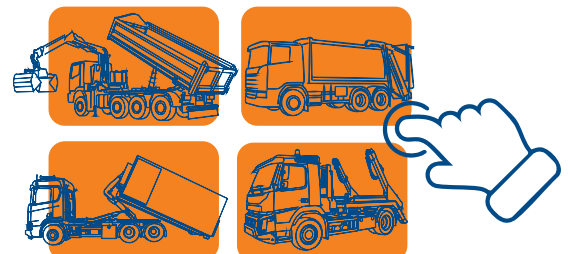

**OIL TANKS**

p	11	26/36
p	11	36/26
p	12	44/54
p	13	50/64
p	14	50/64 T20
p	15	63/70
p	16	70/63
p	17	70/70
p	18	70/70 R
p	19	63/27
p	20	TLine 85/18

**DIESEL TANKS**

p	23	26/36
p	23	44/54
p	24	50/64
p	24	64/50
p	25	63/70
p	26	70/63
p	27	70/70

**COMBINED TANKS**

p	29	50/64
p	30	64/50
p	31	63/70
p	32	70/70

**ACCESSORIES OIL TANKS**

p	34	Semi-immersed Return Filters
p	34	Immersed Return Filters for Easy Kit
p	34	Immersed Easy Filters (360°)
p	34	In-line filters
p	35	Filter's clogging visual indicator
p	35	Aluminium cover with return connection and pipe
p	35	Air breather caps
p	35	Level indicators
p	36	Adjustable ball valves
p	36	Pipe fittings
p	36	Adjustable fittings

**ACCESSORIES DIESEL TANKS**

p	38	Diesel level indicators/sensors
p	38	Analogic cabin diesel indicator
p	38	Diesel connection kits
p	39	Diesel caps
p	39	VDO Cap

# LIST BY CAPACITY

OIL TANKS	L / TANK SIDEWALL	26/36	36/26	44/54	50/64	50/64 T20	63/70	70/63	70/70	70/70R	63/27	TLIne 85/18
	30	p 11	p 11									
	40	p 11	p 11									
	50	p 11	p 11									
	60-70			p 12								
	75				p 13	p 14						
	80			p 12								
	90			p 12	p 13					p 18		
	100				p 13	p 14						
	110										p 19	
	120				p 13	p 14	p 15	p 16				
	130				p 13				p 17			
	135						p 15	p 16			p 19	
	140					p 14						
	150				p 13	p 14	p 15	p 16	p 17			p 20
	160				p 13							
	170						p 15	p 16	p 17			
	180									p 18	p 19	p 20
	200					p 14	p 15	p 16	p 17		p 19	p 20
	215				p 13							
	250					p 14	p 15		p 17			
	300					p 14						
	400					p 14						

DIESEL TANKS	L / TANK SIDEWALL	26/36	44/54	50/64	64/50	63/70	70/63	70/70
	60	p 23						
	80	p 23						
	90			p 24	p 24			
	110					p 25	p 26	
	120	p 23						
	125							p 27
	135					p 25	p 26	
	160							p 27
	170							p 27
	180		p 23					
	200					p 25	p 26	p 27
	210		p 23					
	215							p 27
	240					p 25	p 26	
	250		p 23					
	260							p 27
	280			p 24	p 24			
	290					p 25	p 26	
	300		p 23					
	310							p 27

continue →



**DIESEL  
TANKS**

L / TANK SIDEWALL	26/36	44/54	50/64	64/50	63/70	70/63	70/70
350			p 24	p 24			p 27
360					p 25	p 26	
400					p 25	p 26	p 27
425			p 24	p 24			
445							p 27
450			p 24	p 24	p 25	p 26	
500					p 25	p 26	p 27
520			p 24	p 24			
540							p 27
550					p 25	p 26	
570			p 24	p 24			
590							p 27
600					p 25	p 26	
650					p 25	p 26	
670					p 25	p 26	
680							p 27
730					p 25	p 26	
815					p 25	p 26	p 27
910							p 27
960							p 27

**COMBINED  
TANKS**

L (DIESEL/ OIL) / TANK SIDEWALL	50/64	64/50	63/70	70/70
125/140			p 31	
140/170			p 31	
150/150				p 32
160/120	p 29	p 30		
160/150			p 31	
175/105	p 29	p 30		
180/170			p 31	
190/200			p 31	
190/90	p 29	p 30		
200/150			p 31	p 32
200/200				p 32
220/170			p 31	p 32
280/170				p 32
280/200			p 31	
300/200				p 32
340/200				p 32
380/200			p 31	
400/200				p 32
410/170			p 31	
480/200				p 32
600/200			p 31	p 32
700/200				p 32



# OIL TANKS

## 26/36 (sidewalls 260 mm h x 360 mm w)



Download specifics  
www.padoan.it/documents/Padoan\_OIL\_26-36\_EN.pdf



Mounting kit available:

**SIDE**

Materials available:

**A** Aluminium  
**F** Painted steel RAL 7021

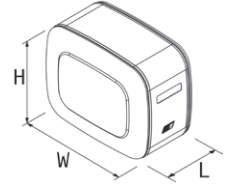

Product	L*	Features included	Filter Flange Code	Dimensions Only tank L x H x W	Material	Product code NSOA= Aluminium NSOF = Painted Steel	Mounting kit
Multi Function (MF)	40	- spy eye 3/4" - suction connection 1" 1/4 - air breather cap h 43mm	135	465 x 260 x 360	A	- 0040046H000	Side: AKMISLT263640N0
	50			565 x 260 x 360	A	- 0050056H000	
	30			365 x 260 x 360	F	- 0030036H000	Side mounting kit included (welded)
	40			465 x 260 x 360	F	- 0040046H000	
	50			565 x 260 x 360	F	- 0050056H000	

\* Full tank capacity - Scan the qr code for level indicator capacity and technical features

Accessories pp 34-36

AKMISLT263640N0

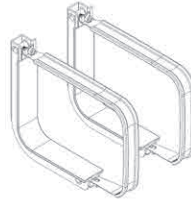

Side mounting kit with two brackets and stainless steel straps (40mm)

## 36/26 (sidewalls 360 mm h x 260 mm w)



Download specifics  
www.padoan.it/documents/Padoan\_OIL\_36-26\_EN.pdf



Mounting kit available:

**REAR**

Material available:

**F** Painted Steel RAL 7021

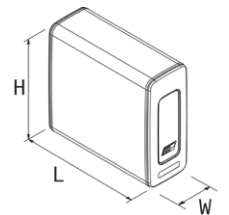

Product	L*	Features included	Filter Flange Code	Dimensions Only tank L x H x W	Material	Product code NSOF = Painted Steel	Mounting kit
Multi Function (MF)	30	- spy eye 3/4" - suction connection 1" 1/4 - air breather cap h 43mm	135	365 x 360 x 260	F	- 0030036V000	Rear mounting kit included (welded)
	40			465 x 360 x 260	F	- 0040046V000	
	50			565 x 360 x 260	F	- 0050056V000	

\* Full tank capacity - Scan the qr code for level indicator capacity and technical features

Accessories pp 34-36

# 44/54 (sidewalls 440 mm h x 540 mm w)



Download specifics  
[www.padoan.it/documents/Padoan\\_OIL\\_44-54\\_EN.pdf](http://www.padoan.it/documents/Padoan_OIL_44-54_EN.pdf)



Mounting kit available for:



Materials available:

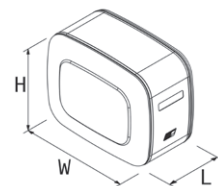

Product	L*	Features included	Filter Flange Code	Dimensions Only tank L x H x W	Material	Product code NSOA= Aluminium NSOF = Painted Steel	Mounting kit
Multi Function (MF)	60-70	- level gauge 127mm - suction connection 1" 1/4 - return connection 1" - air breather h 43mm - adjustable ball valve 1" 1/4	135	350 x 440 x 540	A/F	- 0070035MF00	Side: AKMISLT44544000  Rear: AKMISRC04405404
	80	- spy eye 1" - suction connection 1" 1/4 - return connection 1"		400 x 440 x 540	A/F	- 0080040MF00	
	90	- air breather h 43mm - adjustable ball valve 1" 1/4		450 x 440 x 540	A/F	- 0090045MF00	

\* Full tank capacity - Scan the qr code for level indicator capacity and technical features

Accessories pp 34-36

AKMISLT44544000

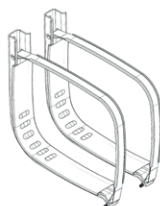

Side mounting kit with two brackets and stainless steel straps (40mm)

AKMISRC04405404



Rear mounting kit with two brackets and stainless steel straps (40mm)

# 50/64 (sidewalls 500 mm h x 640 mm w)



Download specifics  
www.padoan.it/documents/Padoan\_OIL\_50-64\_EN.pdf



Mounting kit available for:



Materials available:

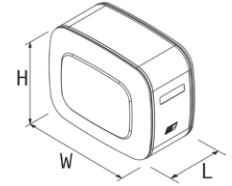
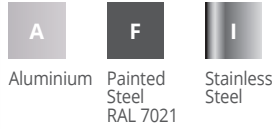

Product	L*	Features included	Filter Flange Code	Dimensions Only tank L x H x W	Material	Product code NSOA: Aluminium NSOF: Painted steel NSOI: Stainless steel	Mounting kit
Multi Function (MF)	90	- spy eye 1" - suction connection 1" 1/4 - return connection 1" - air breather h 43mm - adjustable ball valve 1" 1/4	135	350 x 500 x 640	A/F/I	- 0090035MF00	Side: AKMISLT50644000  Rear: AKMISRC05006404
	100	- spy eye 1" - suction connection 1" 1/2 - return connection 1" - air breather h 43mm - adjustable ball valve 1" 1/2		400 x 500 x 640	A/F/I	- 0100040MF00	Side: AKMISLT50645000  Rear: AKMISRC05006405
	120			450 x 500 x 640	A/F/I	- 0120045MF00	
	130			500 x 500 x 640	A/F/I	- 0130050MF00	
	150			550 x 500 x 640	A/F/I	- 0150055MF00	
	160			600 x 500 x 640	A/F/I	- 0160060MF00	
	215	780 x 500 x 640		A/F/I	- 0215078MF00		
Monobacket	75	- spy eye 1" - suction connection 1" 1/4 - return connection 1" - air breather h 43mm - adjustable ball valve 1" 1/4	135	300 x 500 x 640	A/F	- 0075030CF00	Monobacket side mounting kit included
Compact	75	- spy eye 1" - suction connection 1" 1/4 - 2x return connection 1" - air breather h 43mm - adjustable ball valve 1" 1/4	135	300 x 500 x 640	A/F	- 0075030RC00	Rear mounting kit included
	90			350 x 500 x 640	F	- 0090035RC00	
	100			400 x 500 x 640	F/I	- 0100040RC00	
	120			450 x 500 x 640	F	- 0120045RC00	

\* Full tank capacity - Scan the qr code for level indicator capacity and technical features

Accessories pp 34-36

AKMISLT50644000

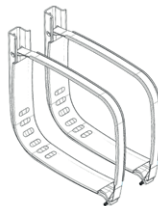

Side mounting kit with two brackets and stainless steel straps (40mm)

AKMISLT50645000

Side mounting kit with two brackets and stainless steel straps (50mm)

AKMISRC05006404



Rear mounting kit with two brackets and stainless steel straps (40mm)

AKMISRC05006405

Rear mounting kit with two brackets and stainless steel straps (50mm)

# 50/64 T20 (sidewalls 500 mm h x 640 mm w)



Download specifics  
[www.padoan.it/documents/Padoan\\_OIL\\_50-64\\_T20\\_EN.pdf](http://www.padoan.it/documents/Padoan_OIL_50-64_T20_EN.pdf)



Mounting kit available:



Materials available:

- A  
Aluminium
- F  
Painted Steel  
RAL 7021
- I  
Stainless Steel

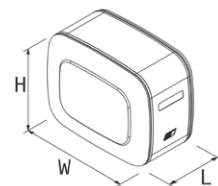

Product	L*	Features included	Filter Flange Code	Dimensions Only tank L x H x W	Material	Product code NSOA: Aluminium NSOF: Painted steel NSOI: Stainless steel	Mounting kit
T20	75	- level gauge 254mm with thermometer - suction connection 1" 1/2 - return connection 3/4" - air breather 43mm - adjustable ball valve 1" 1/2	135	300x500x640	A/F	- 0075030PD00	Monobacket side mounting kit included
	100	- level gauge 254mm with thermometer - suction connection 2" - return connection 3/4" - air breather 43mm - adjustable ball valve 2"	195	400x500x640	A/F/I	- 0100040PD00	Side: AKMISLTT2564000
	120			470x500x640	A/F/I	- 0120047PD00	
	140			530x500x640	A/F/I	- 0140053PD00	
	150			570x500x640	A/F/I	- 0150057PD00	
	200			750x500x640	A/F/I	- 0200075PD00	
	250	- level gauge 254mm with thermometer - suction connection 2x 2" - return connection 2x 3/4" - air breather 43mm - adjustable ball valve 2"	930x500x640	A/F/I	- 0250093PD00	Side: AKMISLTT2560000	
	300	- level gauge 254mm with thermometer - suction connection 2x 2" 1/2 - return connection 2x 3/4"	1100x500x640	A/F/I	- 0300110PD00		
	400	- air breather 43mm - adjustable ball valve 2" 1/2	1500x500x640	A/F/I	- 0400150PD00		

\* Full tank capacity - Scan the qr code for level indicator capacity and technical features

Accessories pp 34-36

AKMISLTT2564000

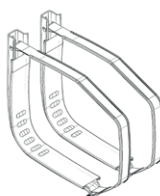

Side mounting kit with two brackets and stainless steel straps (40mm)

AKMISLTT2560000

Side mounting kit with two brackets and stainless steel straps (50mm)

# 63/70 (sidewalls 636 mm h x 706 mm w)



Download specifics  
[www.padoan.it/documents/Padoan\\_OIL\\_63-70\\_EN.pdf](http://www.padoan.it/documents/Padoan_OIL_63-70_EN.pdf)



Mounting kit available:



Materials available:

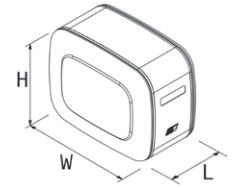
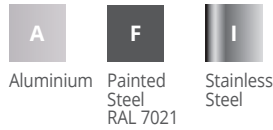

Product	L*	Features included	Filter Flange Code	Dimensions Only tank L x H x W	Material	Product code NSOA: Aluminium NSOF: Painted steel NSOI: Stainless steel	Mounting kit
Multi Function (MF)	135	- spy eye 1" - suction connection 1" 1/2 - 2x return connection 1"	135	350 x 636 x 706	A/F/I	- 0135035MF00	Side: AKMISLT06307004 Rear: AKMISRC06307004
	150	- return connection 1" 1/4		400 x 636 x 706	A/F/I	- 0150040FM00	Side: AKMISLT06307005 Rear: AKMISRC06307005
	170	- air breather cap h 43mm		450 x 636 x 706	A/F/I	- 0170045MF00	
	200	- adjustable ball valve 1" 1/2		500 x 636 x 706	A/F/I	- 0200050MF00	
	250	- spy eye 1" - suction connection 2" - 2x return connection 1" - air breather cap h 43mm - adjustable ball valve 2"	195	600 x 636 x 706	A/F/I	- 0250060CF00	
Monobacket	120	- spy eye 1" - suction connection 1" 1/2	135	300 x 636 x 706	A/F/I	- 0120030MFMS	Monobacket side mounting kit included
	135	- return connection 1" - air breather cap h 43mm - adjustable ball valve 1" 1/2		350 x 636 x 706	A/F/I	- 0135035MFMS	
Valve Plate (MFPG)	135	- spy eye 1" - suction connection 1" 1/2	135	350 x 636 x 706	A/F/I	- 0135035MFPG	Side: AKMISLT06307004 Rear: AKMISRC06307004
	150	- 2x return connection 1"		400 x 636 x 706	A/F/I	- 0150040MFPG	Side: AKMISLT06307005 Rear: AKMISRC06307005
	170	- air breather cap h 43mm		450 x 636 x 706	A/F/I	- 0170045MFPG	
	200	- adjustable ball valve 1" 1/2		500 x 636 x 706	A/F/I	- 0200050MFPG	
	250			600 x 636 x 706	A/F/I	- 0250060MFPG	
Compact	135	- spy eye 1" - suction connection 1" 1/4 - return connection 1" - air breather cap h 43mm - adjustable ball valve 1" 1/4	135	350 x 636 x 706	A/F/I	- 0135035RC00	Rear mounting Kit Included

\* Full tank capacity - Scan the qr code for level indicator capacity and technical features

Accessories pp 34-36

AKMISLT06307004



Side mounting kit with two brackets and stainless steel straps (40mm)

AKMISLT06307005



Side mounting kit with two brackets and stainless steel straps (50mm)

AKMISRC06307004



Rear mounting kit with two brackets and stainless steel straps (40mm)

AKMISRC06307005

Rear mounting kit with two brackets and stainless steel straps (50mm)

# 70/63 (sidewalls 706 mm h x 636 mm w)



Mounting kit available:



Materials available:

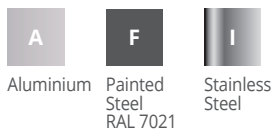



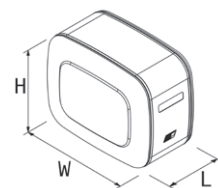

Download specifics  
[www.padoan.it/documents/Padoan\\_OIL\\_70-63\\_EN.pdf](http://www.padoan.it/documents/Padoan_OIL_70-63_EN.pdf)

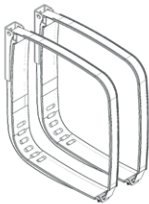

Product	L*	Features included	Filter Flange Code	Dimensions Only tank L x H x W	Material	Product code NSOA: Aluminium NSOF: Painted steel NSOI: Stainless steel	Mounting kit
Multi Function (MF)	135	- spy eye 1" - suction connection 1" 1/2 - 2x return connection 1"	135	350 x 706 x 636	F/I	- 0135035CORV	Side: AKMISLT70634000 Rear: AKMISRC70634000
	150	- return connection 1" 1/4		400 x 706 x 636	A/F/I	- 0150040CORV	Side: AKMISLT07006305 Rear: AKMISRC07006305
	170	- air breather cap h 43mm - adjustable ball valve 1" 1/2		450 x 706 x 636	A/F/I	- 0170045CORV	
	200			500 x 706 x 636	A/F/I	- 0200050CORV	
Monobacket	120	- spy eye 1" - suction connection 1" 1/2 - return connection 1" - air breather cap h 43mm - adjustable ball valve 1" 1/2	/	300 x 706 x 636	A/F	- 0120030CORV	Monobacket side mounting kit included

\* Full tank capacity - Scan the qr code for level indicator capacity and technical features

**Accessories pp 34-36**

AKMISLT70634000		Side mounting kit with two brackets and stainless steel straps (40mm)
AKMISLT07006305		Side mounting kit with two brackets and stainless steel straps (50mm)
AKMISRC70634000		Rear mounting kit with two brackets and stainless steel straps (40mm)
AKMISRC07006305		Rear mounting kit with two brackets and stainless steel straps (50mm)



# 70/70 (sidewalls 700 mm h x 700 mm w)



Mounting kit available:



Materials available:



Download specifics  
[www.padoan.it/documents/Padoan\\_OIL\\_70-70\\_EN.pdf](http://www.padoan.it/documents/Padoan_OIL_70-70_EN.pdf)

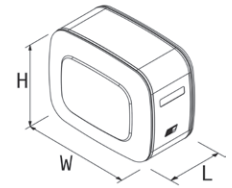

Product	L*	Features included	Filter Flange Code	Dimensions Only tank L x H x W	Material	Product code NSOA: Aluminium NSOF: Painted steel	Mounting kit
Multi Function (MF)	150	- spy eye 1" - suction connection 1" 1/2 - 2x return connection 1" - return connection 1" 1/4	135	350 x 700 x 700	A/F	- 0150035MF00	Side: AKMISLT70704000  Rear: AKMISRC70704000
	170	- air breather cap h 43mm - adjustable ball valve 1" 1/2		400 x 700 x 700	A/F	- 0170040MF00	Side: AKMISLT07007005  Rear: AKMISRC07007005
	200			450 x 700 x 700	A/F	- 0200045MF00	
	250	- spy eye 1" - suction connection 2" - 2x return connection 1" - air breather cap h 43mm - adjustable ball valve 2"	195	550 x 700 x 700	A/F	- 0250055CF00	
Monobacket	130	- spy eye 1" - suction connection 1" 1/2 - return connection 1" - air breather cap h 43mm - adjustable ball valve 1" 1/2	135	300 x 700 x 700	A/F	- 0130030CF00	Monobacket side mounting kit included

\* Full tank capacity - Scan the qr code for level indicator capacity and technical features

Accessories pp 34-36

AKMISLT70704000

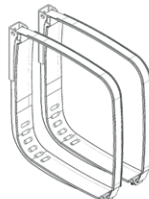

Side mounting kit with two brackets and stainless steel straps (40mm)

AKMISLT07007005

Side mounting kit with two brackets and stainless steel straps (50mm)

AKMISRC70704000



Rear mounting kit with two brackets and stainless steel straps (40mm)

AKMISRC07007005

Side mounting kit with two brackets and stainless steel straps (50mm)

**70/70 R** (sidewalls 700 mm h x 700 mm w)



Download specifics  
[www.padoan.it/documents/Padoan\\_OIL\\_70-70\\_EN\\_rearcabin.pdf](http://www.padoan.it/documents/Padoan_OIL_70-70_EN_rearcabin.pdf)



Mounting kit available:



Material available:



Aluminium

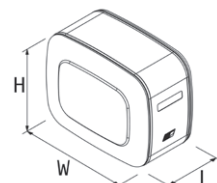

Product	L*	Features included	Filter Flange Code	Dimensions Only tank L x H x W	Material	Product code NKOA: Aluminium	Mounting kit
70/70R	90	Master: - spy eye 1" - suction connection 1" 1/2 - return connection 1" - air connection 1/2" - air breather cap h 43mm	/	230 x 700 x 700	A	- 0090023RC01	Rear mounting kit included (beam)
	180	Master: - spy eye 1" - suction connection 1" 1/2 - return connection 1" - air connection 1/2" - air breather cap h 43mm  'Slave - suction connection 1" 1/2 - return connection 1" - air connection 1/2"		230 x 700 x 700		- 0180023RC01	

\* Full tank capacity - Scan the qr code for level indicator capacity and technical features



**63/27** (sidewalls 638 mm h x 270 mm w)



Download specifics  
[www.padoan.it/documents/Padoan\\_OIL\\_63-27\\_EN.pdf](http://www.padoan.it/documents/Padoan_OIL_63-27_EN.pdf)

Mounting kit available:

**REAR**

Materials available:



Aluminium



Painted Steel  
RAL 7021



Stainless Steel

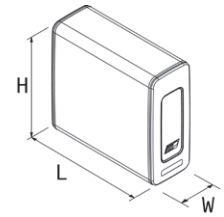

Product	L*	Features included	Filter Flange Code	Dimensions Only tank L x H x W	Material	Product code NSOA: Aluminium NSOF: Painted steel NSOI: Stainless steel	Mounting kit
Classic (RC)	110	- spy eye 1"	135	700 x 638 x 270	A/F/I	- 0110070RC10	Rear: AKMI06302705NTR AKMISBZ632750N0
	135	- suction connection 1" 1/4 - air breather cap h 69mm - adjustable ball valve 1" 1/4		860 x 638 x 270	A/F/I	- 0135086RC10	
	180	- spy eye 1"		1150 x 638 x 270	A/F/I	- 01800115RC10	Rear: AKMI06302705NTR AKMFRFT632750N0
	200	- suction connection 1" 1/2 - air breather cap h 69mm - adjustable ball valve 1" 1/2		1260 x 638 x 270	A/F/I	- 0200126RC10	
2 Filter Flange (RC30)	200	- spy eye 1" - 2x suction connection 1" 1/2 - return connection 1" - air breather cap h 69mm - adjustable ball valve 1" 1/2	2 x 135	1260 x 638 x 270	A/F/I	- 0200126RC40	

\* Full tank capacity - Scan the qr code for level indicator capacity and technical features

Accessories pp 34-36

AKMISBZ632750N0

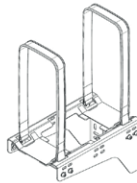

Shelf rear mounting kit with stainless steel straps (50mm)

AKMI06302705NTR



Rear mounting kit with two brackets and stainless steel straps (50mm)

AKMFRFT632750N0

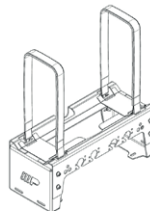

Beam rear mounting kit with stainless steel straps (50mm)

Product images are for illustrative purposes only and might be different according to the actual product, accessories and mounting kit version

# TLine 85/18 (sidewalls 850 mm h x 180 mm w)



Download specifics  
[www.padoan.it/documents/Padoan\\_OIL\\_85-18\\_TLINE\\_EN.pdf](http://www.padoan.it/documents/Padoan_OIL_85-18_TLINE_EN.pdf)



Mounting kit available:



Materials available:



Aluminium

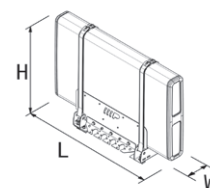

Product	L*	Capacity	Accessories included	Filter Flange Code	Dimensions Only tank L x H x W	Material	Product code NSOA: Aluminium	Mounting kit
Tline 85/18	150	150	- level indicator - 2 x 1/2" connection - return side connection on - return tank connection 1" on - additional weather vent - installation instructions - air breather - breather vent ** - 90° suction fitting for - adjustable valve 1" 1/2 - metal support plate for - connectors	135	1065 x 850 x 180	A	- 0150106PD00	Rear mounting kit with vibration-damping clamps included (beam)
	180	180			1265 x 850 x 180	A	- 0180126PD00	
	200	200			1415 x 850 x 180	A	- 0200141PD00	

\* Full tank capacity - Scan the qr code for level indicator capacity and technical features  
 \*\* Included in 180 and 200L versions

Accessories pp 34-36

## Specific accessories for TLine

### Suzie plate

Image	Products Range	Description	Specifics	Product Code	Spare Parts
	Tline 85/18	Suzie plate	Upper suzie plate fixing kit for cables (holes to be drilled according to installation requirements)	AKM0SPC851800N0	/

### Spacer with multi-hole layout (chassis adapter)

Image	Products Range	Description	Specifics	Product Code	Spare Parts
	Tline 85/18	Spacer with multi-hole layout	Painted steel spacer (81mm) to increase the distance from the chassis. Multiple hole layout for different positions.	AKMFRFT851800N0	/



81.60



# DIESEL TANKS

## 26/36 (sidewalls 260 mm h x 360 mm w)



Mounting kit available:

**SIDE**

Materials available:

A

Aluminium

F

Painted Steel  
RAL 7021

Download specifics  
[www.padoan.it/documents/Padoan\\_DIESEL\\_26-36\\_EN.pdf](http://www.padoan.it/documents/Padoan_DIESEL_26-36_EN.pdf)

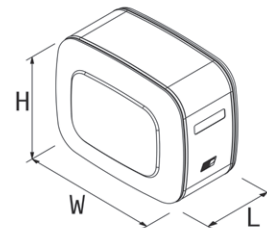

Products range	L*	Features included	Dimensions (only tank) L x H x W	Material	Product code NSGA: Aluminium NSGF: Painted steel	Mounting kit
26/36 diesel	60	- plastic diesel cap ø80mm with bayonet connection, key and breathing/safety valve	675 x 260 x 360	A/F	- 0060067C100	Side mounting kit included
	80		895 x 260 x 360	A/F	- 0080090C100	
	120	- bayonet flange (for VDO diesel level indicator/sensor) - diesel drainage - homologation ECE34 Part III for side installation	1315 x 260 x 360	A/F	- 0120132C100	

\* Full tank capacity

Accessories pp 38-39

## 44/54 (sidewalls 440 mm h x 540 mm w)



Mounting kit available:

**SIDE**

Materials available:

A

Aluminium

F

Painted Steel  
RAL 7021

Download specifics  
[www.padoan.it/documents/Padoan\\_DIESEL\\_44-54\\_EN.pdf](http://www.padoan.it/documents/Padoan_DIESEL_44-54_EN.pdf)

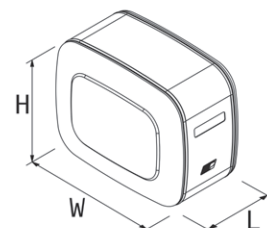

Products range	L*	Features included	Dimensions (only tank) L x H x W	Material	Product code NSGA: Aluminium NSGF: Painted steel	Mounting kit
44/54 diesel	180	- plastic diesel cap ø80mm with bayonet connection, key and breathing/safety valve	850 x 440 x 540	A/F	- 0180085C100	Side mounting kit included
	210		1000 x 440 x 540	A/F	- 0210100C100	
	250		1200 x 440 x 540	A/F	- 0250120C100	
	300	- bayonet flange (for VDO diesel level indicator/sensor) - diesel drainage - homologation ECE34 Part III for side installation	1400 x 440 x 540	A/F	- 0300140C100	

\* Full tank capacity

Accessories pp 38-39



## 50/64 (sidewalls 500 mm h x 640 mm w)



Mounting kit available:

**SIDE**

Download specifics  
[www.padoan.it/documents/Padoan\\_DIESEL\\_50-64\\_EN.pdf](http://www.padoan.it/documents/Padoan_DIESEL_50-64_EN.pdf)

Materials available:

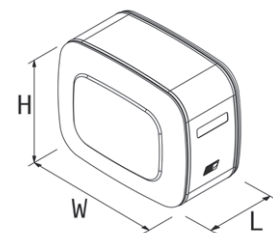
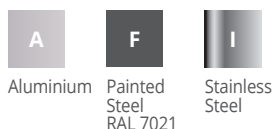

Products range	L*	Features included	Dimensions (only tank) L x H x W	Material	Product code NSGA: Aluminium NSGF: Painted steel NSGI: Stainless steel	Mounting kit
50/64 diesel	90	- plastic diesel cap ø80mm with bayonet connection, key and breathing/safety valve - bayonet flange (for VDO diesel level indicator/sensor) - diesel drainage - homologation ECE34 Part III for side installation	350 x 500 x 640	A/F/I	- 0090035C100	Side mounting kit included
	280		1000 x 500 x 640	A/F/I	- 0300100C100	
	350		1250 x 500 x 640	A/F/I	- 0380125C100	
	425		1500 x 500 x 640	A/F/I	- 0400150C100	
	450		1600 x 500 x 640	A/F/I	- 0500160C100	
	520		1800 x 500 x 640	A/F/I	- 0550180C100	
	570		2000 x 500 x 640	A/F/I	- 0600200C100	

\* Full tank capacity

Accessories pp 38-39



## 64/50 (sidewalls 640 mm h x 500 mm w)\*\*



Mounting kit available:

**SIDE**

Download specifics  
[www.padoan.it/documents/Padoan\\_DIESEL\\_64-50\\_EN.pdf](http://www.padoan.it/documents/Padoan_DIESEL_64-50_EN.pdf)

Materials available:

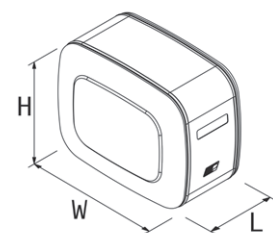
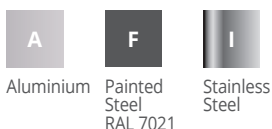

Products range	L*	Features included	Dimensions (only tank) L x H x W	Material	Product code NSGA: Aluminium NSGF: Painted steel NSGI: Stainless steel	Mounting kit
64/50 diesel	90	- plastic diesel cap ø80mm with bayonet connection, key and breathing/safety valve - bayonet flange (for VDO diesel level indicator/sensor) - diesel drainage - homologation ECE34 Part III for side installation	350 x 640 x 500	A/F/I	- 0090035C1RV	Side mounting kit included
	280		1000 x 640 x 500	A/F/I	- 0280100C1RV	
	350		1250 x 640 x 500	A/F/I	- 0350125C1RV	
	425		1500 x 640 x 500	A/F/I	- 0425150C1RV	
	450		1600 x 640 x 500	A/F/I	- 0450160C1RV	
	520		1800 x 640 x 500	A/F/I	- 0520180C1RV	
	570		2000 x 640 x 500	A/F/I	- 0600200C1RV	

\* Full tank capacity \*\* Upon request

Accessories pp 38-39



# 63/70 (sidewalls 636 mm h x 706 mm w)



Download specifics  
[www.padoan.it/documents/Padoan\\_DIESEL\\_63-70\\_EN.pdf](http://www.padoan.it/documents/Padoan_DIESEL_63-70_EN.pdf)



Mounting kit available:

**SIDE**

Materials available:

- A
  - F
  - I
- Aluminium   Painted Steel RAL 7021   Stainless Steel

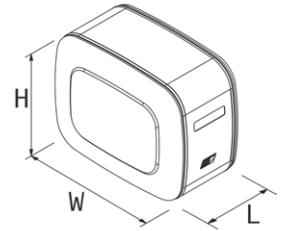

Products range	L*	Features included	Dimensions (only tank) L x H x W	Material	Product code NSGA: Aluminium NSGF: Painted steel NSGI: Stainless steel	Mounting kit
63/70 diesel	110	- plastic diesel cap ø80mm with bayonet connection, key and breathing/safety valve - bayonet flange (for VDO diesel level indicator/sensor) - diesel drainage - homologation ECE34 Part III for side installation	300 x 636 x 706	A/F/I	- 0120030C100	Side mounting kit included
	135		350 x 636 x 706	A/F/I	- 0135035C100	
	200		500 x 636 x 706	A/F/I	- 0200050C100	
	240		610 x 636 x 706	A/F/I	- 0250061C100	
	290		735 x 636 x 706	A/F/I	- 0300073C100	
	360		900 x 636 x 706	A/F/I	- 0350090C100	
	400		1000 x 636 x 706	A/F/I	- 0400100C100	
	450		1110 x 636 x 706	A/F/I	- 0450111C100	
	500		1250 x 636 x 706	A/F/I	- 0500125C100	
	550		1360 x 636 x 706	A/F/I	- 0550136C100	
	600		1500 x 636 x 706	A/F/I	- 0600150C100	
	650		1610 x 636 x 706	A/F/I	- 0650161C100	
	670		1700 x 636 x 706	A/F/I	- 0670170C100	
	730		1800 x 636 x 706	A/F/I	- 0700180C100	
	815		2000 x 636 x 706	A/F/I	- 0800200C100	

\* Full tank capacity

Accessories pp 38-39

Product images are for illustrative purposes only and might be different according to the actual product, accessories and mounting kit version

## 70/63 (sidewalls 706 mm h x 636 mm w)\*\*



Download specifics  
[www.padoan.it/documents/Padoan\\_DIESEL\\_70-63\\_EN.pdf](http://www.padoan.it/documents/Padoan_DIESEL_70-63_EN.pdf)



Mounting kit available for:

**SIDE**

Materials available:

<b>A</b>	<b>F</b>	<b>I</b>
Aluminium	Painted Steel RAL 7021	Stainless Steel

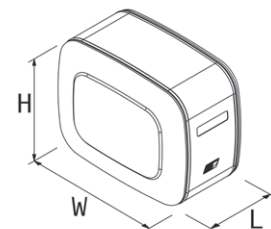

Products range	L*	Features included	Dimensions (only tank) L x H x W	Material	Product code NSGA: Aluminium NSGF: Painted steel NSGI: Stainless steel	Mounting kit
70/63 diesel	110	- plastic diesel cap ø80mm with bayonet connection, key and breathing/safety valve - bayonet flange (for VDO diesel level indicator/sensor) - diesel drainage - homologation ECE34 Part III for side installation	300 x 706 x 636	A/F/I	- 0110030C1RV	Side mounting kit included
	135		350 x 706 x 636	A/F/I	- 0135035C1RV	
	200		500 x 706 x 636	A/F/I	- 0200050C1RV	
	240		610 x 706 x 636	A/F/I	- 0250061C1RV	
	290		735 x 706 x 636	A/F/I	- 0300073C1RV	
	360		900 x 706 x 636	A/F/I	- 0350090C1RV	
	400		1000 x 706 x 636	A/F/I	- 0400100C1RV	
	450		1110 x 706 x 636	A/F/I	- 0450111C1RV	
	500		1250 x 706 x 636	A/F/I	- 0500125C1RV	
	550		1360 x 706 x 636	A/F/I	- 0550136C1RV	
	600		1500 x 706 x 636	A/F/I	- 0600150C1RV	
	650		1610 x 706 x 636	A/F/I	- 0650161C1RV	
	670		1700 x 706 x 636	A/F/I	- 0670170C1RV	
	730		1800 x 706 x 636	A/F/I	- 0700180C1RV	
815	2000 x 706 x 636	A/F/I	- 0800200C1RV			

\* Full tank capacity    \*\* Upon request

Accessories pp 38-39



## 70/70 (sidewalls 700 mm h x 700 mm w)



Mounting kit available for:

**SIDE**

Download specifics  
[www.padoan.it/documents/Padoan\\_DIESEL\\_70-70\\_EN.pdf](http://www.padoan.it/documents/Padoan_DIESEL_70-70_EN.pdf)

Materials available:

**A** Aluminium  
**F** Painted Steel RAL 7021

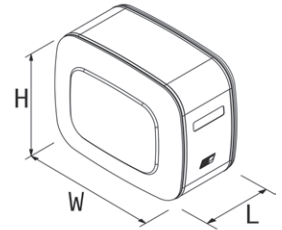

Products range	L*	Features included	Dimensions (only tank) L x H x W	Material	Product code NSGA: Aluminium NSGF: Painted steel	Mounting kit
70/70 diesel	125	<ul style="list-style-type: none"> <li>- plastic diesel cap ø80mm with bayonet connection, key and breathing/safety valve</li> <li>- bayonet flange (for VDO diesel level indicator/sensor)</li> <li>- diesel drainage</li> <li>- homologation ECE34 Part III for side installation</li> </ul>	300 x 700 x 700	A/F	- 0140030C100	Side mounting kit included
	160		350 x 700 x 700	A/F	- 0160035C100	
	170		400 x 700 x 700	A/F	- 0190040C100	
	200		450 x 700 x 700	A/F	- 0200045C100	
	215		500 x 700 x 700	A/F	- 0230050C100	
	260		600 x 700 x 700	A/F	- 0280060C100	
	310		700 x 700 x 700	A/F	- 0330070C100	
	350		800 x 700 x 700	A/F	- 0370080C100	
	400		900 x 700 x 700	A/F	- 0400090C100	
	445		1000 x 700 x 700	A/F	- 0460100C100	
	500		1100 x 700 x 700	A/F	- 0500110C100	
	540		1200 x 700 x 700	A/F	- 0550120C100	
	590		1300 x 700 x 700	A/F	- 0600130C100	
	680		1500 x 700 x 700	A/F	- 0700150C100	
	815		1800 x 700 x 700	A/F	- 0800180C100	
910	2000 x 700 x 700	A/F	- 0900200C100			
960	2110 x 700 x 700	A/F	- 0960211C100			

\* Full tank capacity

Accessories pp 38-39



# COMBINED TANKS

# 50/64 (sidewalls 500 mm h x 640 mm w)\*\*



Mounting kit available:

**SIDE**

Download specifics  
[www.padoan.it/documents/Padoan\\_COMBINED\\_50-64\\_EN.pdf](http://www.padoan.it/documents/Padoan_COMBINED_50-64_EN.pdf)

Materials available:

- A  
Aluminium
- F  
Painted Steel  
RAL 7021
- I  
Stainless Steel

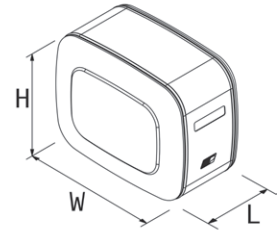

Products range	L* diesel / oil	Features included	Filter flange code (oil)	Dimensions (only tank) L x H x W	Material	Product code NSMA: Aluminium NSMF: Painted steel NSMI: Stainless steel	Mounting kit
50/64 combined Multi Function (MF)	160/120	<b>diesel</b> - plastic diesel cap ø80mm with bayonet connection, key and breathing/safety valve - bayonet flange (for VDO diesel level indicator/sensor) - diesel drainage - homologation ECE34 Part III for side installation <b>oil</b> - spy eye 1" - suction connection 1" 1/2 - air breather cap h 43mm - adjustable ball valve 1" 1/2	135	1000 x 500 x 640	A/F/I	- 0160100C100	Side mounting kit included
	175/105			1000 x 500 x 640	A/F/I	- 0175100C100	
	190/90			1000 x 500 x 640	A/F/I	- 0191100C100	

\* Full tank capacity    \*\* Upon request

Accessories (oil partition) pp 34-36  
 Accessories (diesel partition) pp 38-39

Product images are for illustrative purposes only and might be different according to the actual product, accessories and mounting kit version



**64/50** (sidewalls 640 mm h x 500 mm w)



Mounting kit available:



Download specifics  
[www.padoan.it/documents/Padoan\\_COMBINED\\_64-50\\_EN.pdf](http://www.padoan.it/documents/Padoan_COMBINED_64-50_EN.pdf)

Materials available:

<b>A</b>	<b>F</b>	<b>I</b>
Aluminium	Painted Steel RAL 7021	Stainless Steel

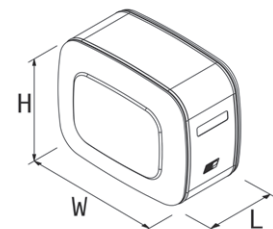

Products range	L* diesel / oil	Features included	Filter flange code (oil)	Dimensions (only tank) L x H x W	Material	Product code NSMA: Aluminium NSMF: Painted steel NSM: Stainless steel	Mounting kit
64/50 combined Multi Function (MF)	160/120	<b>diesel</b> - plastic diesel cap ø80mm with bayonet connection, key and breathing/safety valve - bayonet flange (for VDO diesel level indicator/sensor) - diesel drainage - homologation ECE34 Part III for side installation <b>oil</b> - spy eye 1" - suction connection 1" 1/2 - air breather cap h 43mm - adjustable ball valve 1" 1/2	135	1000 x 640 x 500	A/F/I	- 0160100C1RV	Side mounting kit included
	175/105			1000 x 640 x 500	A/F/I	- 0175100C1RV	
	190/90			1000 x 640 x 500	A/F/I	- 0191100C1RV	

\* Full tank capacity

Accessories (oil partition) pp 34-36  
 Accessories (diesel partition) pp 38-39

# 63/70 (sidewalls 636 mm h x 706 mm w)



Download specifics  
[www.padoan.it/documents/Padoan\\_COMBINED\\_63-70\\_EN.pdf](http://www.padoan.it/documents/Padoan_COMBINED_63-70_EN.pdf)



Mounting kit available:



Materials available:

- A  
Aluminium
- F  
Painted Steel  
RAL 7021
- I  
Stainless Steel

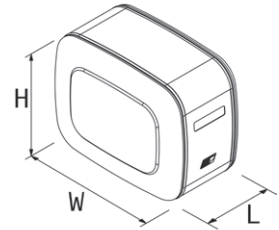

Products range	L* diesel / oil	Features included	Filter flange code (oil)	Dimensions (only tank) L x H x W	Material	Product code NSMA: Aluminium NSMF: Painted steel NSMI: Stainless steel	Mounting kit
63/70 combined Multi Function (MF)	125/140	<b>diesel</b> - plastic diesel cap ø80mm with bayonet connection, key and breathing/safety valve - bayonet flange (for VDO diesel level indicator/sensor) - diesel drainage - homologation ECE34 Part III for side installation <b>oil</b> - spy eye 1" - suction connection 1" 1/2 - air breather cap h 43mm - adjustable ball valve 1" 1/2	135	700 x 636 x 706	A/F/I	- 0125070C100	Side mounting kit included
	140/170			800 x 636 x 706	A/F/I	- 0140080C100	
	160/150			800 x 636 x 706	A/F/I	- 0160080C100	
	180/170			900 x 636 x 706	A/F/I	- 0180090C100	
	190/200			1000 x 636 x 706	A/F/I	- 0190100C100	
	200/150			900 x 636 x 706	A/F/I	- 0200091C100	
	220/170			1000 x 636 x 706	A/F/I	- 0220100C100	
	280/200			1250 x 636 x 706	A/F/I	- 0280125C100	
	380/200			1500 x 636 x 706	A/F/I	- 0380150C100	
	140/170			1500 x 636 x 706	A/F/I	- 04100150C100	
	600/200			2000 x 636 x 706	A/F/I	- 0600200C100	

\* Full tank capacity

Accessories (oil partition) pp 34-36  
 Accessories (diesel partition) pp 38-39

Product images are for illustrative purposes only and might be different according to the actual product, accessories and mounting kit version



**70/70** (sidewalls 700 mm h x 700 mm w)



Download specifics  
[www.padoan.it/documents/Padoan\\_COMBINED\\_70-70\\_EN.pdf](http://www.padoan.it/documents/Padoan_COMBINED_70-70_EN.pdf)

Mounting kit available:



Materials available:

- A Aluminium
- F Painted Steel RAL 7021

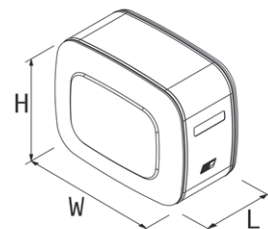

Products range	L* diesel / oil	Features included	Filter flange code (oil)	Dimensions (only tank) L x H x W	Material	Product code NSMA: Aluminium NSMF: Painted steel	Mounting kit
70/70 combined Multi Function (MF)	150/150	<b>diesel</b> - plastic diesel cap ø80mm with bayonet connection, key and breathing/safety valve - bayonet flange (for VDO diesel level indicator/sensor) - diesel drainage - homologation ECE34 Part III for side installation <b>oil</b> - spy eye 1" - suction connection 1" 1/2 - air breather cap h 43mm - adjustable ball valve 1" 1/2	135	700 x 700 x 700	A/F	- 0150070C100	Side mounting kit included
	200/150			800 x 700 x 700	A/F	- 0200080C100	
	200/200			900 x 700 x 700	A/F	- 0200090C100	
	220/170			900 x 700 x 700	A/F	- 0220090C100	
	280/170			1000 x 700 x 700	A/F	- 0280100C100	
	300/200			1100 x 700 x 700	A/F	- 0300110C100	
	340/200			1200 x 700 x 700	A/F	- 0340120C100	
	400/200			1300 x 700 x 700	A/F	- 0400130C100	
	480/200			1500 x 700 x 700	A/F	- 0480150C100	
	600/200			1800 x 700 x 700	A/F	- 0600180C100	
	700/200			2000 x 700 x 700	A/F	- 0700200C100	

\* Full tank capacity

Accessories (oil partition) pp 34-36  
 Accessories (diesel partition) pp 38-39





# ACCESSORIES OIL TANK

**Semi-immersed Return Filters**  
for all tanks excluded 26/36, 36/26 and 70/70R



				Oil and combined tanks	
Filter Flange	l/min flow	Micron / µm	Inlet Connection	Product Code	Spare Parts Cartridge
135	250 L/min	40 µm microfibre	1" 1/4	AFO0SEM136125CF	AFO0ELF205070CF
	200 L/min	21 µm microfibre	1" 1/4	AFO0SEM136125F2	AFO0ELF205070F2
	150 L/min	10 µm paper	1" 1/4	AFO0SEM136125C1	AFO0ELF205070C1
195	300 L/min	60 µm wire mesh	1" 1/4	AFO0SEM195125CL	AFO0ELF210100RM
	250 L/min	21 µm microfibre	1" 1/4	AFO0SEM195125F2	AFO0ELF211099F2
	250 L/min	10 µm paper	1" 1/4	AFO0SEM19512510	AFO0ELF211099C1
195	300 L/min	60 µm wire mesh	1" 1/4 + 3/4"	AFO0SEM195225CL	AFO0ELF210100RM
	250 L/min	21 µm microfibre	1" 1/4 + 3/4"	AFO0SEM195225F2	AFO0ELF211099F2
	250 L/min	10 µm paper	1" 1/4 + 3/4"	AFO0SEM19522510	AFO0ELF211099C1

only for 26/36 – 36/26 oil tanks

135	150 L/min	60 µm wire mesh	1"	AFO0SEM135100ST	AFO0ELF128070BF
	125 L/min	21 µm microfibre	1"	AFO0SEM135100F2	AFO0ELF13007025

**\* Immersed Return Filters for Easy Kit**  
for all tanks excluded 26/36, 36/26, 70/70R and monobacket



				Oil and combined tanks	
Filter Flange	l/min flow	Micron / µm	Inlet Connection	Product Code	Spare Parts Cartridge
135	250 L/min	40 µm microfibre	/	AFO0IMM090340CF	AFO0ELF205070CF
	200 L/min	21 µm microfibre	/	AFO0IMM090340F2	AFO0ELF205070F2
	150 L/min	10 µm paper	/	AFO0IMM090340C1	AFO0ELF205070C1

only for 26/36 – 36/26 oil tanks

135	150 L/min	60 µm wire mesh	1"	AFO0IMM090240RM	AFO0ELF142070RM
	125 L/min	21 µm microfibre	1"	AFO0IMM090240F2	AFO0ELF142070F2



\* Customized valve plates are available on request according to the tipping valve layout required. Inform our team about your requirements.

**Immersed Easy Filters (360°)**  
for all tanks excluded 26/36, 36/26, 70/70R and monobacket



				Oil and combined tanks	
Filter Flange	l/min flow	Micron / µm	Inlet Connection	Product Code	Spare Parts Cartridge
135	220 L/min	40 µm microfibre	1"	AFO0IMM134100CF	AFO0ELF205070CF
	180 L/min	21 µm microfibre	1"	AFO0IMM134100F2	AFO0ELF205070F2
	150 L/min	10 µm paper	1"	AFO0IMM134100C1	AFO0ELF205070C1

only for 26/36 – 36/26 oil tanks

135	150 L/min	60 µm wire mesh	1"	AFO0IMM134101ST	AFO0ELF142070RM
	125 L/min	21 µm microfibre	1"	AFO0IMM134101F2	AFO0ELF142070F2

**In-line filters**



			Oil and combined tanks		
l/min flow	Micron / µm	Inlet connection	Product Code	Spare Parts Cartridge	
150 L/min	25 µm microfibre	1"	AFO0LIN000100F2	AFO0ELF177096F2	
170 L/min	60 µm wire mesh	1"	AFO0LIN000100RM	AFO0ELF177096RM	
230 L/min	25 µm microfibre	1" 1/4	AFO0LIN000125F2	AFO0ELF177096F2	
270 L/min	60 µm wire mesh	1" 1/4	AFO0LIN000125RM	AFO0ELF177096RM	

### Filter's clogging visual indicator



			Oil and combined tanks	
Products Range	Description	Specifics	Product Code	Spare Parts
Oil / Combined tanks	Filter's clogging visual indicator	R 1/8" - EN 10226	AIIOMPF195VSR42	/

### Aluminium cover with return connection and pipe for all tanks with filter flange 135, monobacket excluded



			Oil and combined tanks	
Products Range	Description	Specifics	Product Code	Spare Parts
Oil / Combined tanks	Aluminium cover 160mm	1" return connection and pipe	ACFA1604F010027	/

### Air breather caps



			Oil and combined tanks	
Products Range	Description	Specifics	Product Code	Spare Parts Cartridge
MF MFPG Monobacket Compact T20 and combined tanks for oil partition	Air breather cap with air filter cartridge, fixing screws and anti-splash	43mm (h) air cartridge paper 10 µm 1400 L/min	ATP0PLSCAR0L120	AFA0CARCILT0P20
63/27 RC and RC30 TLINE	Air breather cap with air filter cartridge, fixing screws and anti-splash	69mm (h) air cartridge paper 10 µm 1800 L/min	ATP0PLSCAR0L110	AFA0CARCILT0P10

### Level indicators



			Oil and combined tanks	
Products Range	Description	Specifics	Product Code	Spare Parts
MF (excl. 26/36, 36/26 and 44/54 60-70 L) MFPG Monobacket Compact 63/27 RC and RC30 and combined tanks for oil partition	10x Round aluminium level gauge	1"	AKIOINDLVL100AL	/
MF 26/36 and 36/26	10x Round aluminium level gauge	3/4"	AKIOINDLVL075AL	/
MF 44/54 60-70L	Sight level gauge	not graduated - 127mm distance between centers (M12)	AILOVISLIQ12701	/
T20 and TLINE 85/18	Sight level gauge	not graduated - 254mm distance between centers (M12)	AILOVISLIQ25400	/
		not graduated - 254mm distance between centers (M12) Low electric sensor - 2,5mm wire connection	AILOVISLIQ254CE	/
		graduated - 254mm distance between centers (M12) with thermometer	AILOVISLIQ254TR	/



Product images are for illustrative purposes only and might be different according to the actual product, accessories and mounting kit version

Adjustable ball valves



			Oil and combined tanks		
Products Range	Description	Specifics	Product Code	Spare Parts	
Oil tank / Combined tanks with 1" 1/4 suction connection	Adjustable ball valve M/F with lever	1" 1/4	ARU0ABV12500100	/	
Oil tank / Combined tanks with 1" 1/2 suction connection		1" 1/2	ARU0ABV15000100		
Oil tank / Combined tanks with 2" suction connection		2"	ARU0ABV20000100		
Oil tank / Combined tanks with 2" 1/2 suction connection		2" 1/2	ARU0ABV25000100		

Pipe fittings



			Oil and combined tanks		
Products Range	Description	Specifics	Product Code	Spare Parts	
Oil tank / Combined tanks with 1" 1/4 suction connection	Straight pipe fitting ø40mm hose inox band and sealing	1" 1/4	ARA0PDNPGM12500	/	
	Straight pipe fitting ø50mm hose inox band and sealing	1" 1/4	ARA0PDNPGM12000		
Oil tank / Combined tanks with 1" 1/2 suction connection	Straight pipe fitting ø40mm hose inox band and sealing	1" 1/2	ARA0PDNPGM15100	/	
	Straight pipe fitting ø50mm hose inox band and sealing	1" 1/2	ARA0PDNPGM15000		
Oil tank / Combined tanks with 2" suction connection	Straight pipe fitting ø65mm hose inox band and sealing	2"	ARA0PDNPGM20000		
Oil tank / Combined tanks with 2" 1/2 suction connection	Straight pipe fitting ø64mm hose inox band and sealing	2" 1/2	ARA0PDNPGM25100	/	
	Straight pipe fitting ø75mm hose inox band and sealing	2" 1/2	ARA0PDNPGM25200		



Oil tank / Combined tanks with 1" 1/4 suction connection	45° adjustable pipe fitting ø50mm hose inox band and sealing	1" 1/4	ARA0PDNPGM12025	/
	45° adjustable pipe fitting ø40mm hose inox band and sealing	1" 1/4	ARA0PDNPGM12525	
Oil tank / Combined tanks with 1" 1/2 suction connection	45° adjustable pipe fitting ø50mm hose inox band and sealing	1" 1/2	ARA0PDNPGM15025	



Oil tank / Combined tanks with 1" 1/4 suction connection	90° adjustable pipe fitting ø40mm hose inox band and sealing	1" 1/4	ARA0PDNPGM12550	/
	90° adjustable pipe fitting ø50mm hose inox band and sealing	1" 1/4	ARA0PDNPGM12050	
Oil tank / Combined tanks with 1" 1/2 suction connection	90° adjustable pipe fitting ø50mm hose inox band and sealing	1" 1/2	ARA0PDNPGM15050	
Oil tank / Combined tanks with 2" suction connection	90° adjustable pipe fitting ø65mm hose inox band and sealing	2"	ARA0PDNPGM20050	

Adjustable fittings



			Oil and combined tanks		
Products Range	Description	Specifics	Product Code	Spare Parts	
Oil tank / Combined tanks with 1" 1/4 suction connection	90° adjustable fitting M/F	1" 1/4	ARA0PDNFLT12550	/	
Oil tank / Combined tanks with 1" 1/2 suction connection		1" 1/2	ARA0PDNFLT15050	/	
Oil tank / Combined tanks with 2" 1/2 suction connection		2" 1/2	ARA0PDNFLT25050	/	

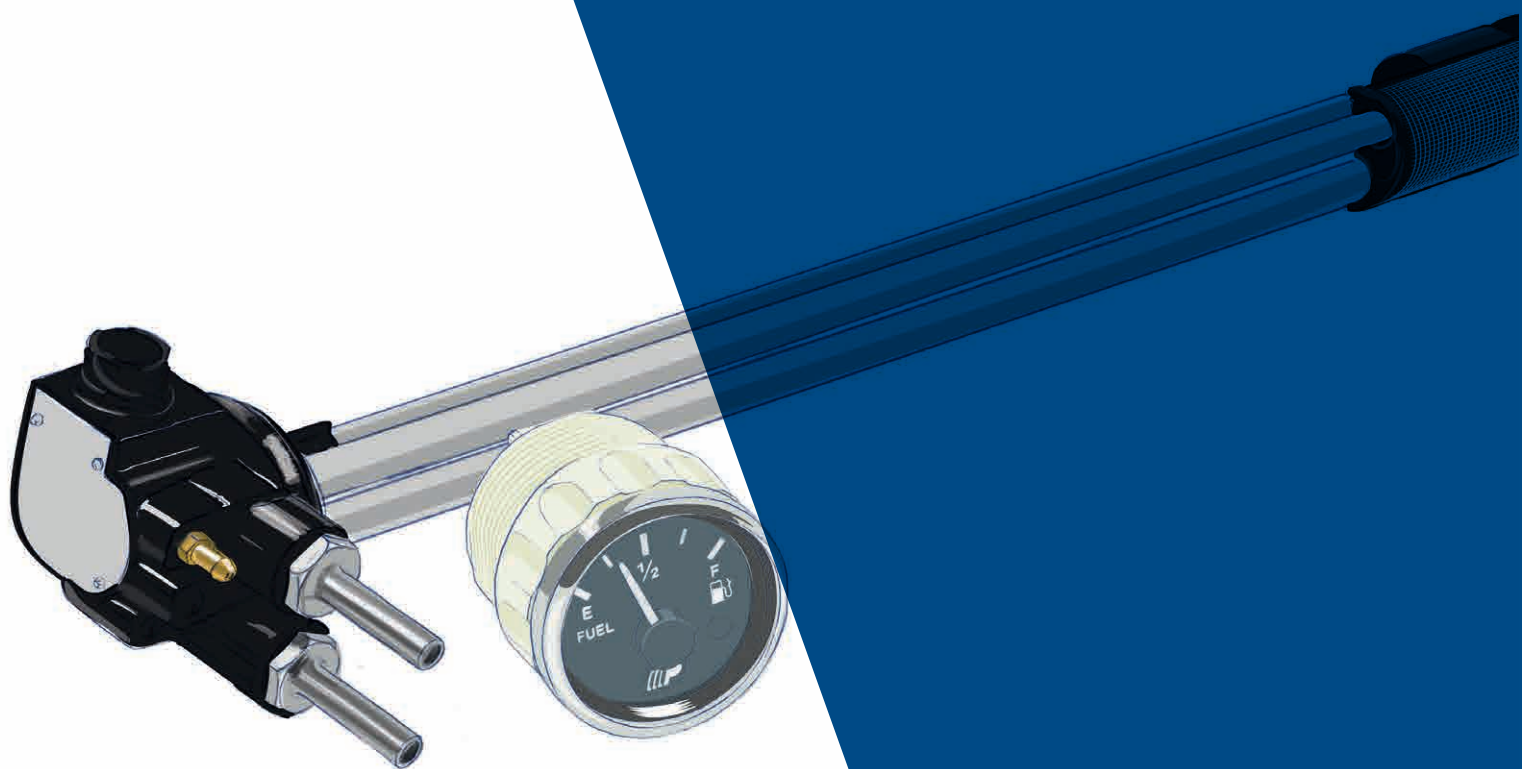

# ACCESSORIES DIESEL TANK

**Diesel level indicators/sensors (for Padoan tanks)**

**Diesel oil and combined tanks**

	Products Range	Description	Specifics	Product Code	Spare Parts
	Diesel tanks 26/36	Suction and return 10mm Bayonet connection 4PIN socket connector with switch low level connection	250mm length	AICOGENV025030	/
	Diesel tanks 44/54		430mm length	AICOGENV043030	/
	Diesel and combined tanks 50/64		490mm length	AICOGENV049030	/
	Diesel and combined tanks 63/70 - 64/50		620mm length	AICOGENV062030	/
	Diesel and combined tanks 70/70		690mm length	AICOGENV069030	/

**Analogic cabin diesel indicator (to be installed with the generic level indicator/sensor and Padoan tank)**

**Diesel oil and combined tanks**

	Products Range	Description	Specifics	Product Code	Spare Parts
	Diesel and combined tanks	Cabin diesel level indicator (to be installed with Padoan diesel tanks and diesel level indicators/sensors)	round screen with reserve signal	AILOGENPDN00000	/

**Diesel connection kits**

**Diesel oil and combined tanks**

	Products Range	Description	Specifics	Product Code	Spare Parts
	Diesel and combined tanks	Connection kit for diesel and combined tanks	pipe lenght 1500mm / ø12mm no. 2 3/4" elbows no. 2 x 3/4" valves no. 2 rubber holders ø12mm	AKA0ABBGAS07500	/
			pipe lenght 3000mm / ø12mm 2x 3/4" elbows 2x 3/4" valves 2x rubber holders ø12mm	AKA0ABBGAS07501	/

**Diesel caps**

			Diesel oil and combined tanks		
Products Range	Description	Specifics	Product Code	Spare Parts	
	Diesel tanks	Diesel caps ø80mm with bayonet connection	plastic cap with key and breathing/ safety valve	/	ATP0CARCARB80CE
	Combined tanks	Diesel caps ø80mm with bayonet connection	plastic cap with key and breathing/ safety valve	/	ATP0CARCARB80FR

**VDO Cap**

			Diesel oil and combined tanks		
Products Range	Description	Specifics	Product Code	Spare Parts	
	Diesel and combined tanks	VDO cap for bayonet flange	metal cap equipped with cover and rubber	ATP0COPATTVDOPC	/

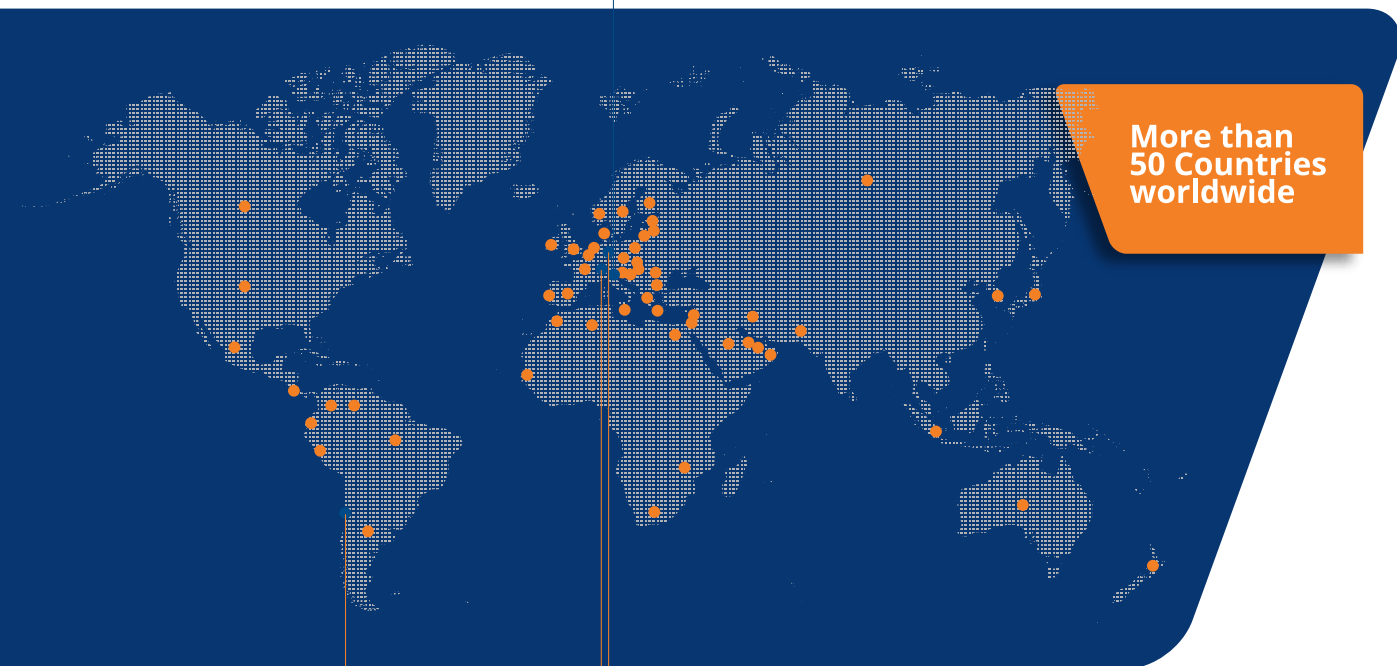

More than 50 Countries worldwide



Padoan Srl  
Via Risorgive, 20  
31048 Olmi di S. Biagio di Callalta (TV) - Italy  
ph. +39 0422 362172  
info@padoan.it - www.padoan.it

Padoan Swiss SA  
San Vittore, Cantone Grigioni - Switzerland

Padoan Deutschland GmbH  
Mönchengladbach - Germany

Padoan Chile da  
Santiago - Chile

