

in y t i f
#tankspecialist

TANK it EASY



brochure/catalogue

 **Padoan**

WETANKYOU SINCE 1937

Our Identity

VISION

We aim to provide the best solutions for applications and industrial vehicles that in turn create value and improve people's lives. Together we build the future.

MISSION

We design and supply solutions for industrial vehicles and machinery with tanks (oil, diesel and combined) and accessories, providing expertise and support right from the planning stage.

As #tankspecialist we identify the best choice for the specific application.

WETANKYOU since 1937.

Family company since 1937, we are a prime manufacturer of oil, diesel and combined tanks for industrial vehicles and machinery.

Our strong focus on R&D, innovation, technology and support to our customers is translated into action by PADOAN GROUP.

We develop our solutions working side by side with our customers who mainly are bodybuilders, OEMs and distribution networks in more than 50 Countries worldwide.

The Italian design and quality mark out our wide range of tanks that is divided in "N" (the standard and multipurpose line) and "X", tanks which are designed and customized according to the customer and application needs.

We look forward to supporting you in reaching your goals.

TANK it easy

Padoan's identity is unique, as a TANKSPECIALIST, and at the same time it is marked by multiple facets that, individually and as a globality, aim to represent added value for those who rely on Padoan to achieve their goals.

The added value can be found in one word: **SOLUTION**.

The world of industrial vehicles and machinery is a complex field, characterised by a plurality of processes, even in procurement.

That is why the services and daily activities ensured by Padoan aim to represent a **plus** that joins the **experience** and **specialisation** on tanks for industrial vehicles and machinery, developed in **more than 85 years of activity**.

Padoan aims to be a partner that takes care of every detail, making your business and professional life easier.

In a few words: **TANK it easy**.

Go to the configurator



www.padoan.it/en/configurator/

Go to the virtual showroom



www.padoan.it/en/virtual-showroom/

Visit Padoan website



www.padoan.it

TANK it EASY



The ANSWER to your project

is at hand thanks to our segmentation. Give us the details of your application or project and we will provide you with the most suitable solution thanks to our expertise.



Value in SUSTAINABILITY

thanks to the certification that can enhance your brand and positioning. ISO14001 is on its way.

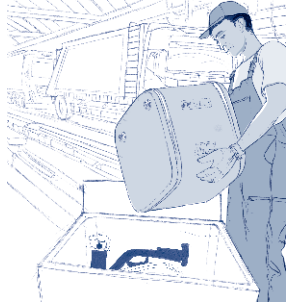

ONE-STOP supply

for filters, indicators, fittings, ball valves, and much more. Everything you require is included in one pack, already assembled, if needed. A plug&play solution that you can simply unpack and install.



Value in PROCESSES

with smooth procedures management also granted by ISO9001.



The whole solution in JUST ONE CODE

since the product reference can include the mounting kit making the order process and warehouse management easier.



Caring for YOUR IDENTITY

because your uniqueness and identity really matter to us. Customization can be the answer.



Smart PROCUREMENT

thanks to a dedicated strategy of production planning with experts monitoring statistical trends.



SUPPLY CHAIN valorisation

because our supplier partners represent a value to share with you to reach your goals.



Easy MANAGEMENT

for your aftersales requests. Outstanding quality merges with ultimate support through the portal available on your smartphone.



Home DELIVERY opportunity

thanks to transport managed by our specialized team.



A special TEAM

of people who are truly involved in your goals and ready to give you the best pre- and post-sales opportunities.

**FOR INDUSTRIAL/
COMMERCIAL VEHICLES
AND MACHINERY**

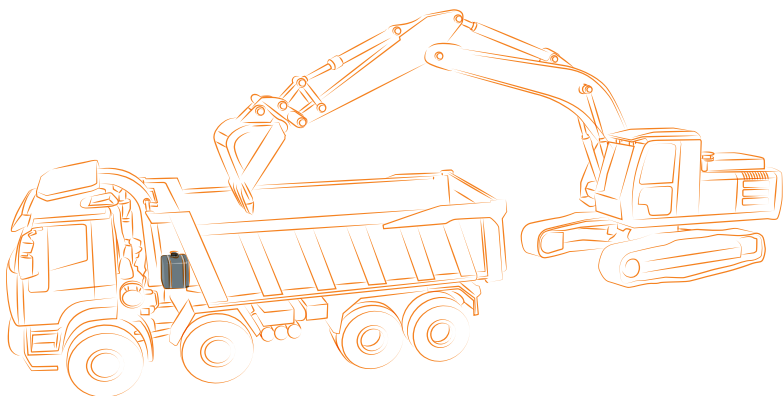
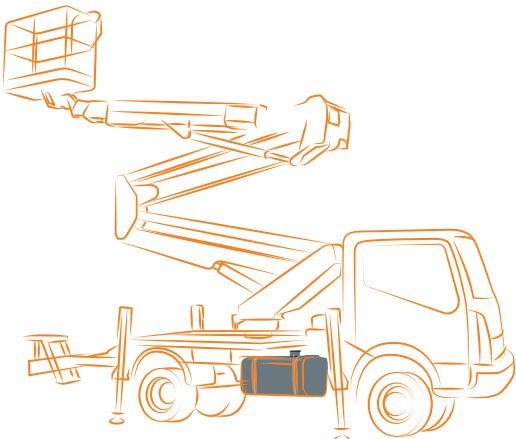
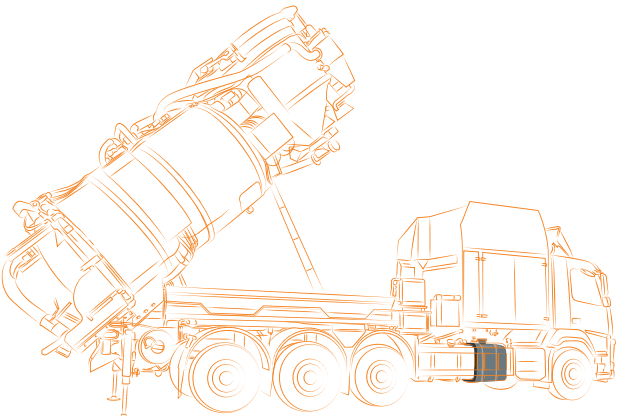
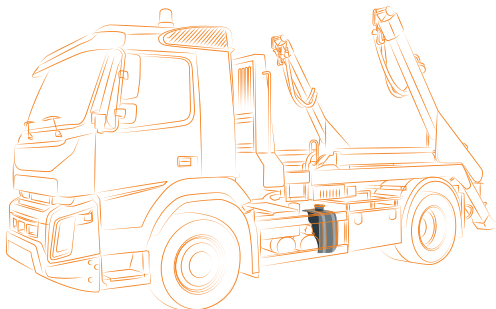
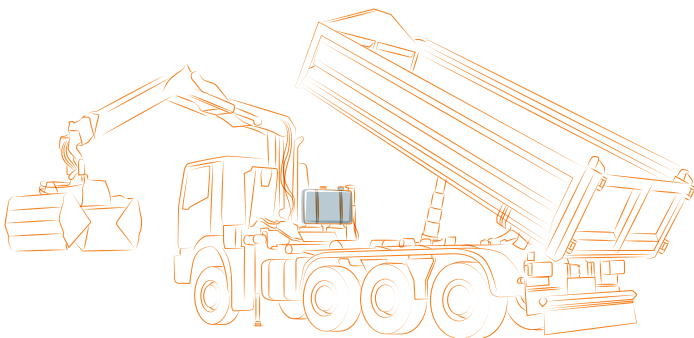
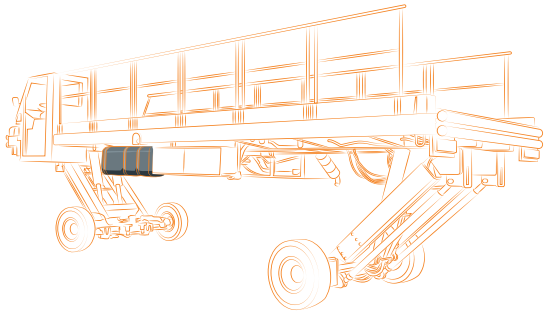
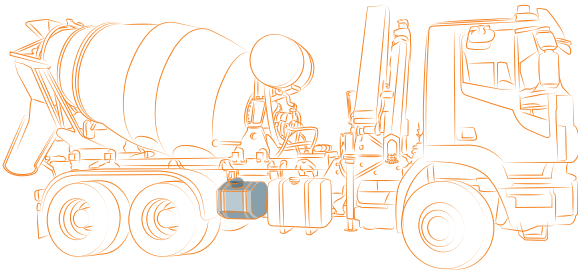

**TANK
SPECIALIST**

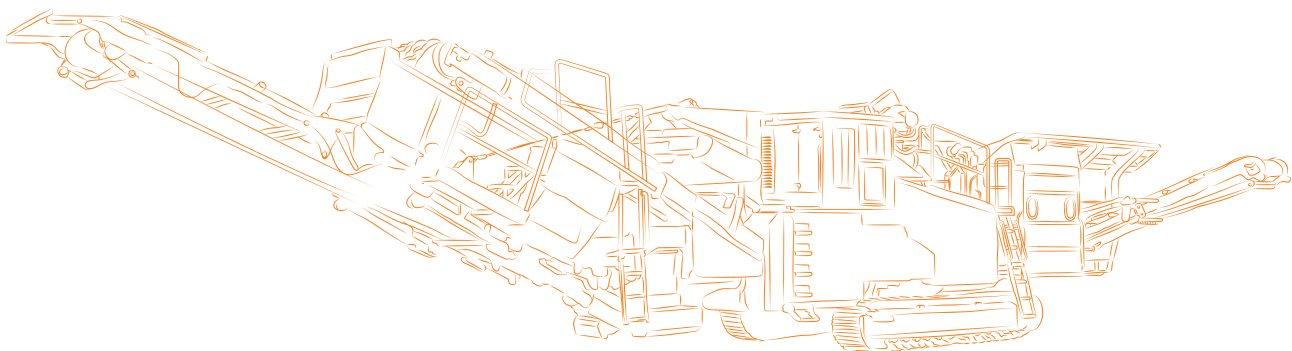
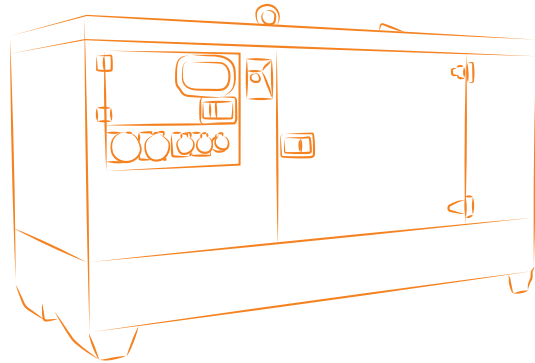
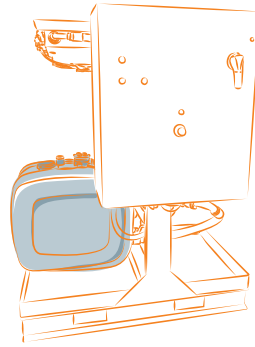
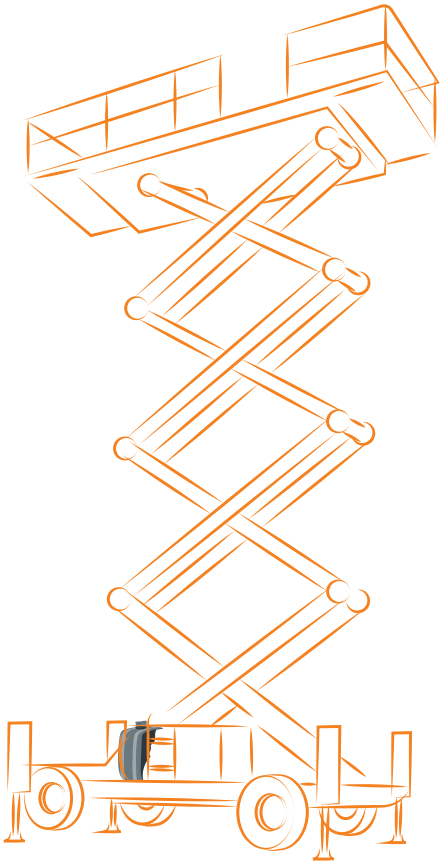
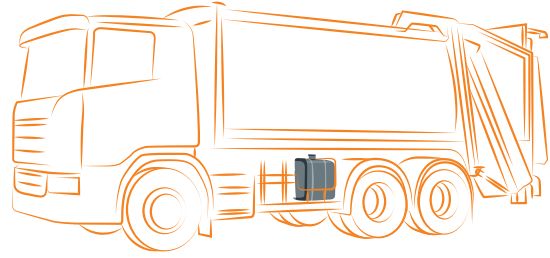
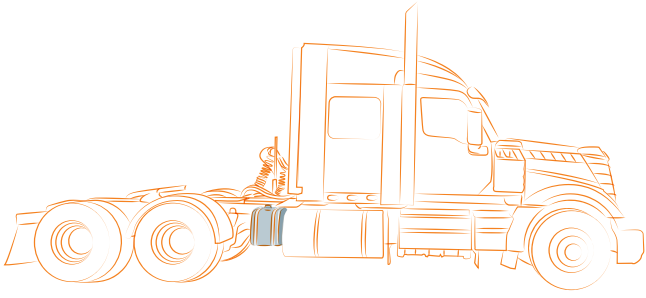

The complete product code is composed by the material code and the product code listed in the table for each item.
(example: **NSOA0070035MF00**)

Download the technical sheet with details

For dimensions with mounting kit, please refer to the technical sheet you can download by scanning the QR Code



44/54 (sidewalls 440 mm h x 540 mm w)

Mounting kit available for:

SIDE REAR

Materials available:

A **F**
Aluminium Painted Steel RAL 7021



Download specifics
www.padoan.it/documents/Padoan_OIL_44-54_EN.pdf

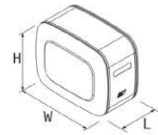

Code of filter flange that couples with Padoan filters

Products range	LT*	Features included	Filter flange code	Dimensions (only tank) L x H x W	Material	Product code NSOA: Aluminium NSOF: Painted steel	Mounting kit code SIDE	Mounting kit code REAR
Multi Function (MF)	60-70	- level gauge 127mm - suction connection 1"1/4 - return connection 1" - air breather cap h 41mm - adjustable ball valve 1" 1/4	135	350 x 440 x 540	A/F	-0070035MF00	AKMISLT44544000	AKMISRC04405404
	80	- spy eye 1" - suction connection 1"1/4 - return connection 1" - air breather cap h 41mm		400 x 440 x 540	A/F	-0080040MF00		
	90	- adjustable ball valve 1" 1/4		450 x 440 x 540	A/F	-0090045MF00		

* Full tank capacity

Accessories pp 30-32

Code for the specific mounting kit

PRODUCTS CATALOGUE

OIL TANKS

p	11	26/36
p	11	36/26
p	12	44/54
p	13	50/64
p	14	50/64 T20
p	15	63/70
p	16	70/63
p	17	70/70
p	18	70/70 R
p	19	63/27
p	20	TLine 85/18

DIESEL TANKS

p	23	26/36
p	23	44/54
p	24	50/64
p	24	64/50
p	25	63/70
p	26	70/63
p	27	70/70

COMBINED TANKS

p	29	50/64
p	30	64/50
p	31	63/70
p	32	70/70

ACCESSORIES OIL TANKS

p	34	Semi-immersed Return Filters
p	34	Immersed Return Filters for Easy Kit
p	34	Immersed Easy Filters
p	34	In-line filters
p	35	Filter's clogging visual indicator
p	35	Aluminium cover with return connection and pipe
p	35	Air breather caps
p	35	Level indicators
p	36	Adjustable ball valves
p	36	Pipe fittings
p	36	Adjustable fittings

ACCESSORIES DIESEL TANKS

p	38	Diesel level indicators (for Padoan tanks)
p	38	Analogic cabin diesel oil indicator (to be installed with the generic level indicator and Padoan tanks)
p	38	Diesel connection kits
p	39	Fuel caps
p	39	VDO Cap

LIST BY CAPACITY

OIL TANKS	L / TANK SIDEWALL	26/36	36/26	44/54	50/64	50/64 T20	63/70	70/63	70/70	70/70R	63/27	TLIne 85/18
	30	p 11	p 11									
	40	p 11	p 11									
	50	p 11	p 11									
	60-70			p 12								
	75				p 13	p 14						
	80			p 12								
	90			p 12	p 13					p 18		
	100				p 13	p 14						
	110										p 19	
	120				p 13	p 14	p 15	p 16				
	130				p 13				p 17			
	135						p 15	p 16			p 19	
	140					p 14						
	150				p 13	p 14	p 15	p 16	p 17			p 20
	160				p 13							
	170						p 15	p 16	p 17			
	180									p 18	p 19	p 20
	200					p 14	p 15	p 16	p 17		p 19	p 20
	215				p 13							
	250					p 14	p 15		p 17			
	300					p 14						
	400					p 14						

DIESEL TANKS	L / TANK SIDEWALL	26/36	44/54	50/64	64/50	63/70	70/63	70/70
	60	p 23						
	80	p 23						
	90			p 24	p 24			
	110					p 25	p 26	
	120	p 23						
	125							p 27
	135					p 25	p 26	
	160							p 27
	170							p 27
	180		p 23					
	200					p 25	p 26	p 27
	210		p 23					
	215							p 27
	240					p 25	p 26	
	250		p 23					
	260							p 27
	280			p 24	p 24			
	290					p 25	p 26	
	300		p 23					
	310							p 27

continue →

**DIESEL
TANKS**

L / TANK SIDEWALL	26/36	44/54	50/64	64/50	63/70	70/63	70/70
350			p 24	p 24			p 27
360					p 25	p 26	
400					p 25	p 26	p 27
425			p 24	p 24			
445							p 27
450			p 24	p 24	p 25	p 26	
500					p 25	p 26	p 27
520			p 24	p 24			
540							p 27
550					p 25	p 26	
570			p 24	p 24			
590							p 27
600					p 25	p 26	
650					p 25	p 26	
670					p 25	p 26	
680							p 27
730					p 25	p 26	
815					p 25	p 26	p 27
910							p 27
960							p 27

**COMBINED
TANKS**

L (DIESEL/ OIL) / TANK SIDEWALL	50/64	64/50	63/70	70/70
125/140			p 31	
140/170			p 31	
150/150				p 32
160/120	p 29	p 30		
160/150			p 31	
175/105	p 29	p 30		
180/170			p 31	
190/200			p 31	
190/90	p 29	p 30		
200/150			p 31	p 32
200/200				p 32
220/170			p 31	p 32
280/170				p 32
280/200			p 31	
300/200				p 32
340/200				p 32
380/200			p 31	
400/200				p 32
410/170			p 31	
480/200				p 32
600/200			p 31	p 32
700/200				p 32



OIL TANKS

26/36 (sidewalls 260 mm h x 360 mm w)



Download specifics
www.padoan.it/documents/Padoan_OIL_26-36_EN.pdf

Mounting kit available:

SIDE

Materials available:

A

Aluminium

F

Painted
Steel
RAL 7021

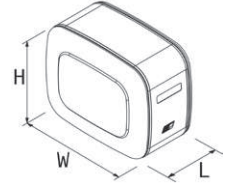

Products range	L*	Features included	Filter Flange Code	Dimensions (only tank) L x H x W	Material	Product code NSOA: Aluminium NSOF: Painted steel	Mounting kit code SIDE	Mounting kit code REAR
Multi Function (MF)	40	- spy eye 3/4" - suction connection 1"1/4	135	465 x 260 x 360	A	-0040046H000	AKMISLT263640N0	/
	50			565 x 260 x 360	A	-0050056H000		
Multi Function (MF)	30	- air breather cap h 41mm	135	365 x 260 x 360	F	-0030036H000	welded mounting kit included	/
	40			465 x 260 x 360	F	-0040046H000		
	50			565 x 260 x 360	F	-0050056H000		

* Full tank capacity

Accessories pp 34-36

36/26 (sidewalls 360 mm h x 260 mm w)



Download specifics
www.padoan.it/documents/Padoan_OIL_36-26_EN.pdf

Mounting kit available:

REAR

Material available:

F

Painted
Steel
RAL 7021

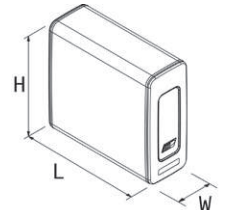

Products range	L*	Features included	Filter Flange Code	Dimensions (only tank) L x H x W	Material	Product Code NSOF: Painted steel	Mounting kit code SIDE	Mounting kit code REAR
Multi Function (MF)	30	- spy eye 3/4" - suction connection 1"1/4 - air breather cap h 41mm	135	365 x 360 x 260	F	-0030036V000	/	welded mounting kit included
	40			465 x 360 x 260	F	-0040046V000		
	50			565 x 360 x 260	F	-0050056V000		

* Full tank capacity

Accessories pp 34-36

44/54 (sidewalls 440 mm h x 540 mm w)



Download specifics
www.padoan.it/documents/Padoan_OIL_44-54_EN.pdf



Mounting kit available for:



Materials available:

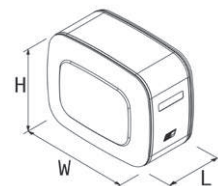

Products range	L*	Features included	Filter flange code	Dimensions (only tank) L x H x W	Material	Product code NSOA: Aluminium NSOF: Painted steel	Mounting kit code SIDE	Mounting kit code REAR
Multi Function (MF)	60-70	- level gauge 127mm - suction connection 1"1/4 - return connection 1" - air breather cap h 41mm - adjustable ball valve 1" 1/4	135	350 x 440 x 540	A/F	-0070035MF00	AKMISLT44544000	AKMISRC04405404
	80	- spy eye 1" - suction connection 1"1/4 - return connection 1"		400 x 440 x 540	A/F	-0080040MF00		
	90	- air breather cap h 41mm - adjustable ball valve 1" 1/4		450 x 440 x 540	A/F	-0090045MF00		

* Full tank capacity

Accessories pp 34-36

50/64 (sidewalls 500 mm h x 640 mm w)



Mounting kit available for:



Materials available:

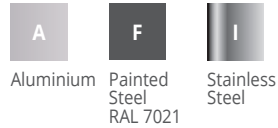

Download specifics
www.padoan.it/documents/Padoan_OIL_50-64_EN.pdf

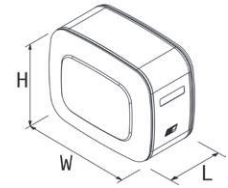

Products range	L*	Features included	Filter flange code	Dimensions (only tank) L x H x W	Material	Product code NSOA: Aluminium NSOF: Painted steel NSOI: Stainless steel	Mounting kit code SIDE	Mounting kit code REAR		
Multi Function (MF)	90	- spy eye 1" - suction connection 1"1/4 - return connection 1" - air breather cap h 41mm adjustable ball valve 1" 1/4	135	350 x 500 x 640	A/F/I	-0090035MF00	AKMISLT50644000	AKMISRC05006404		
	100	- spy eye 1"		400 x 500 x 640	A/F/I	-0100040MF00				
	120	- suction connection 1"1/2		450 x 500 x 640	A/F/I	-0120045MF00				
	130	- return connection 1"		500 x 500 x 640	A/F/I	-0130050MF00			AKMISLT50645000	AKMISRC05006405
	150	- air breather cap h 41mm		550 x 500 x 640	A/F/I	-0150055MF00				
	160	- adjustable ball valve 1" 1/2		600 x 500 x 640	A/F/I	-0160060MF00				
	215			780 x 500 x 640	A/F/I	-0215078MF00				
Monobacket	75	- spy eye 1" - suction connection 1"1/4 - return connection 1" - air breather cap h 41mm - adjustable ball valve 1" 1/4	135	300 x 500 x 640	A/F	-0075030CF00	included	/		
Compact	75	- spy eye 1" - suction connection 1"1/4	135	300 x 500 x 640	A/F	-0075030RC00	/	included		
	90	- 2x return connection 1"		350 x 500 x 640	F	-0090035RC00				
	100	- air breather cap h 41mm		400 x 500 x 640	F/I	-0100040RC00				
	120	- adjustable ball valve 1" 1/4		450 x 500 x 640	F	-0120045RC00				

* Full tank capacity

Accessories pp 34-36

Product images are for illustrative purposes only and might be different according to the actual product, accessories and mounting kit version

50/64 T20 (sidewalls 500 mm h x 640 mm w)



Download specifics
www.padoan.it/documents/Padoan_OIL_50-64_T20_EN.pdf



Mounting kit available:

SIDE

Materials available:

- A
Aluminium
- F
Painted Steel
RAL 7021
- I
Stainless Steel

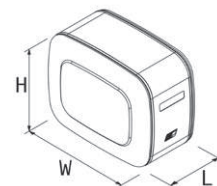

Products range	L*	Features included	Filter flange code	Dimensions (only tank) L x H x W	Material	Product code NSOA: Aluminium NSOF: Painted steel NSOI: Stainless steel	Mounting kit code SIDE	Mounting kit code REAR
T20	75	- air breather cap h 41mm - suction connection 1" 1/2 To define according to customers requirements: - level gauge - return connection - adjustable ball valve	135	300 x 500 x 640	A/F	-0075030T200	AKMIMS0T25640N0	
	100	- air breather cap h 41mm	195	400 x 500 x 640	A/F/I	-0100040T200	AKMISLTT2564000	/
	120	- suction connection 2"		470 x 500 x 640	A/F/I	-0120047T200		
	140			530 x 500 x 640	A/F/I	-0140053T200		
	150	To define according to customers requirements:		570 x 500 x 640	A/F/I	-0150057T200		
	200	- level gauge		750 x 500 x 640	A/F/I	-0200075T200		
	250	- return connection - adjustable ball valve		930 x 500 x 640	A/F/I	-0250093T200		
	300	- air breather cap h 41mm - suction connection 2" 1/2		1100 x 500 x 640	A/F/I	-0300110T200	AKMISLTT2560000	
	400	To define according to customers requirements: - level gauge - return connection - adjustable ball valve		1500 x 500 x 640	A/F/I	-0400150T200		

* Full tank capacity

Accessories pp 34-36

63/70 (sidewalls 636 mm h x 706 mm w)



Download specifics
www.padoan.it/documents/Padoan_OIL_63-70_EN.pdf



Mounting kit available:



Materials available:

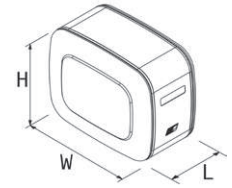
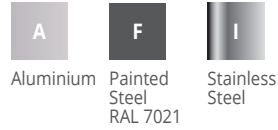

Products range	L*	Features included	Filter flange code	Dimensions (only tank) L x H x W	Material	Product code NSOA: Aluminium NSOF: Painted steel NSOI: Stainless steel	Mounting kit code SIDE	Mounting kit code REAR
Multi Function (MF)	135	- spy eye 1"	135	350 x 636 x 706	A/F/I	-0135035MF00	SIDE	REAR
	150	- suction connection 1" 1/2		400 x 636 x 706	A/F/I	-0150040MF00		
	170	- 2 x return connection 1"		450 x 636 x 706	A/F/I	-0170045MF00		
	200	- return connection 1" 1/4		500 x 636 x 706	A/F/I	-0200050MF00		
		- air breather cap h 41mm						
	250	- adjustable ball valve 1" 1/2	195	600 x 636 x 706	A/F/I	-0250060CF00	AKMISLT06307005	AKMISRC06307005
Monobacket	120	- spy eye 1"	135	300 x 636 x 706	A/F/I	-0120030CF00	included	/
	135	- suction connection 1" 1/2		350 x 636 x 706	A/F/I	-0135035MFMS		
Valve Plate (MFPG)	135	- return connection 1"	135	350 x 636 x 706	A/F/I	-0135035MFPG	AKMISLT06307005	AKMISRC06307005
	150	- spy eye 1"		400 x 636 x 706	A/F/I	-0150040MFPG		
	170	- suction connection 1" 1/2		450 x 636 x 706	A/F/I	-0170045MFPG		
	200	- 2 x return connection 1"		500 x 636 x 706	A/F/I	-0200050MFPG		
	250	- air breather cap h 41mm		600 x 636 x 706	A/F/I	-0250060MFPG		
Compact	135	- adjustable ball valve 1" 1/2	135	350 x 636 x 706	A/F/I	-0135035RC00	/	included

* Full tank capacity

Accessories pp 34-36

Product images are for illustrative purposes only and might be different according to the actual product, accessories and mounting kit version



70/63 (sidewalls 706 mm h x 636 mm w)

Mounting kit available:



Materials available:

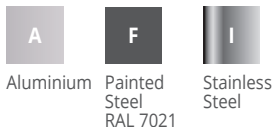

Download specifics
www.padoan.it/documents/Padoan_OIL_70-63_EN.pdf

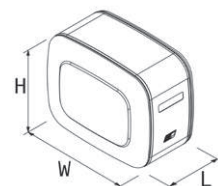

Products range	L*	Features included	Filter flange code	Dimensions (only tank) L x H x W	Material	Product code NSOA: Aluminium NSOF: Painted steel NSOI: Stainless steel	Mounting kit code 	Mounting kit code 
Multi Function (MF)	135	- spy eye 1" - suction connection 1" 1/2	135	350 x 706 x 636	F/I	-0135035C0RV	AKMISLT07006305	AKMISRC07006305
	150	- 2 x return connection 1"		400 x 706 x 636	A/F/I	-0150040C0RV		
	170	- return connection 1" 1/4 - air breather cap h 41mm		450 x 706 x 636	A/F/I	-0170045C0RV		
	200	- adjustable ball valve 1" 1/2		500 x 706 x 636	A/F/I	-0200050C0RV		
Monobacket	120	- spy eye 1" - suction connection 1" 1/2 - return connection 1" - air breather cap h 41mm - adjustable ball valve 1" 1/2	/	300 x 706 x 636	A/F	-0120030C0RV	included	/

* Full tank capacity

Accessories pp 34-36

70/70 (sidewalls 700 mm h x 700 mm w)



Download specifics
www.padoan.it/documents/Padoan_OIL_70-70_EN.pdf



Mounting kit available:



Materials available:

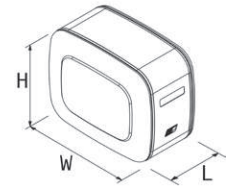

Products range	L*	Features included	Filter flange code	Dimensions (only tank) L x H x W	Material	Product code NSOA: Aluminium NSOF: Painted steel	Mounting kit code SIDE	Mounting kit code REAR
Multi Function (MF)	150	- spy eye 1" - suction connection 1" 1/2	135	350 x 700 x 700	A/F	-0150035MF00	AKMISLT07007005	AKMISRC07007005
	170	- 2 x return connection 1" - return connection 1" 1/4 - air breather cap h 41mm		400 x 700 x 700	A/F	-0170040MF00		
	200	- adjustable ball valve 1" 1/2		450 x 700 x 700	A/F	-0200045MF00		
	250	- spy eye 1" - suction connection 2" - 2 x return connection 1" - air breather cap h 41mm - adjustable ball valve 2"		550 x 700 x 700	A/F	-0250055CF00		
Monobacket	130	- spy eye 1" - suction connection 1" 1/2 - return connection 1" - air breather cap h 41mm - adjustable ball valve 1" 1/2	135	300 x 700 x 700	A/F	-0130030CF00	included	/

* Full tank capacity

Accessories pp 34-36

Product images are for illustrative purposes only and might be different according to the actual product, accessories and mounting kit version

70/70 R (sidewalls 700 mm h x 700 mm w)



Download specifics
www.padoan.it/documents/Padoan_OIL_70-70_EN_rearcabin.pdf

Mounting kit available:



REAR

Material available:



Aluminium

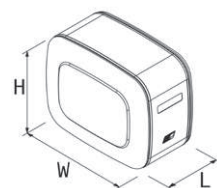

MASTER

SLAVE

Products range	L*	Features included	Filter flange code	Dimensions (only tank) L x H x W	Material	Product code NKOA: Aluminium	Mounting kit code	Mounting kit code
70/70R	90	Master: - spy eye 1" - suction connection 1" 1/2 - return connection 1" - air connection 1/2" - air breather cap h 41mm	/	230 x 700 x 700	A	- 0090023RC01	SIDE	REAR
	180	Master: - spy eye 1" - suction connection 1" 1/2 - return connection 1" - air connection 1/2" - air breather cap h 41mm Slave: - suction connection 1" 1/2 - return connection 1" - air connection 1/2"		230 x 700 x 700		- 0180023RC01	/	included

* Full tank capacity



63/27 (sidewalls 638 mm h x 270 mm w)



Download specifics
www.padoan.it/documents/Padoan_OIL_63-27_EN.pdf

Mounting kit available:

REAR

Materials available:

A

Aluminium

F

Painted Steel
RAL 7021

I

Stainless Steel

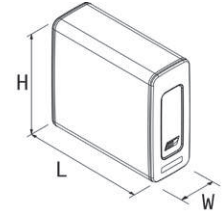

Products range	L*	Features included	Filter flange code	Dimensions (only tank) L x H x W	Material	Product code NSOA: Aluminium NSOF: Painted steel NSOI: Stainless steel	Mounting kit code SIDE	Mounting kit code REAR
Classic (RC)	110	- spy eye 1" - suction connection 1" 1/4	135	700 x 638 x 270	A/F/I	-0110070RC00	/	included
	135	- air breather cap h 69mm - adjustable ball valve 1" 1/4		860 x 638 x 270	A/F/I	-0135086RC00		
	180	- spy eye 1" - suction connection 1" 1/2		1150 x 638 x 270	A/F/I	-0180115RC00		
	200	- air breather cap h 69mm - adjustable ball valve 1" 1/2		1260 x 638 x 270	A/F/I	-0200126RC00		
2 Filter Flange (RC30)	200	- spy eye 1" - suction connection 1" 1/2 - return connection 1" - air breather cap h 69mm - adjustable ball valve 1" 1/2	2 x 135	1260 x 638 x 270	A/F/I	-0200126RC30		

* Full tank capacity

Accessories pp 34-36



TLine 85/18 (sidewalls 850 mm h x 180 mm w)



Download specifics
www.padoan.it/documents/Padoan_OIL_85-18_TLINE_EN.pdf

Mounting kit available:

REAR

Materials available:

A

Aluminium

F

Painted Steel**
RAL 7021

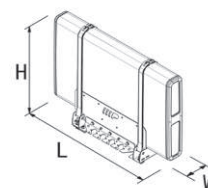

Products range	L*	Features included	Filter Flange Code	Dimensions (only tank) L x H x W	Material	Product code NSOA = Aluminium NSOF = Painted Steel**	Mounting kit code SIDE	Mounting kit code REAR
TLine 85/18	150	- level gauge 127 mm with thermometer - 2 x suction connection 1"1/2 - return connection on sidewall 1"	135	1065x850x180	A / F**	-0150106PD00	/	mounting kit with shock absorber
	180	- return connection 1" on tank body available for additional breather vent installation		1265x850x180		-0180126PD00		
	200	- air breather cap h 69mm - breather vent*** - 90°adjustable fitting for suction connection 1"1/2 - adjustable ball valve 1"1/2 - metal support plate for cable connectors		1415x850x180		-0200141PD00		

* Full tank capacity

** Upon request

*** Included in 180 and 200LT versions

Specific accessories for TLine

Suzie plate

Products Range	Description	Specifics	Product Code	Spare Parts
Tline 85/18	Suzie plate	Upper suzie plate fixing kit for cables (holes to be drilled according to installation requirements)	AKM0SPC851800N0	/

Spacer with multi-hole layout (chassis adapter)

Products Range	Description	Specifics	Product Code	Spare Parts
Tline 85/18	Spacer with multi-hole layout	Painted steel spacer (81mm) to increase the distance from the chassis. Multiple hole layout for different positions.	AKMFRFT851800N0	/



81.60



DIESEL TANKS



26/36 (sidewalls 260 mm h x 360 mm w)



Mounting kit available:

SIDE

Download specifics
www.padoan.it/documents/Padoan_DIESEL_26-36_EN.pdf

Materials available:

A **F**
 Aluminium Painted Steel
 RAL 7021

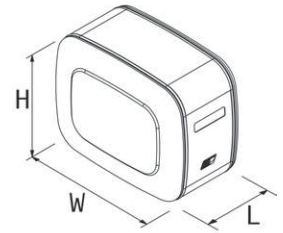

Products range	L*	Features included	Dimensions (only tank) L x H x W	Material	Product code NSGA: Aluminium NSGF: Painted steel	Mounting kit code SIDE
26/36 diesel	60	- fuel cap with key and breathing valve	675 x 260 x 360	A/F	- 0060067C100	Included
	80	- bayonet connection (for VDO level indicator)	895 x 260 x 360		- 0080090C100	
	120	- diesel drainage - homologation ECE34 Part III (side installation)	1315 x 260 x 360		- 0120132C100	

* Full tank capacity

Accessories pp 38-39



44/54 (sidewalls 440 mm h x 540 mm w)



Mounting kit available:

SIDE

Download specifics
www.padoan.it/documents/Padoan_DIESEL_44-54_EN.pdf

Materials available:

A **F**
 Aluminium Painted Steel
 RAL 7021

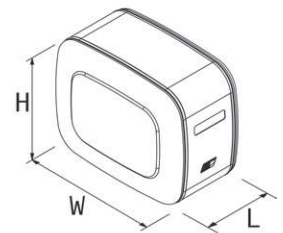

Products range	L*	Features included	Dimensions (only tank) L x H x W	Material	Product code NSGA: Aluminium NSGF: Painted steel	Mounting kit code SIDE
44/54 diesel	180	- fuel cap with key and breathing valve	850 x 440 x 540	A/F	- 0180085C100	Included
	210	- bayonet connection (for VDO level indicator)	1000 x 440 x 540		- 0210100C100	
	250	- diesel drainage	1200 x 440 x 540		- 0250120C100	
	300	- homologation ECE34 Part III (side installation)	1400 x 440 x 540		- 0300140C100	

* Full tank capacity

Accessories pp 38-39

Product images are for illustrative purposes only and might be different according to the actual product, accessories and mounting kit version



50/64 (sidewalls 500 mm h x 640 mm w)

Mounting kit available:

SIDE

Materials available:

A	F	I
Aluminium	Painted Steel RAL 7021	Stainless Steel



Download specifics
www.padoan.it/documents/Padoan_DIESEL_50-64_EN.pdf

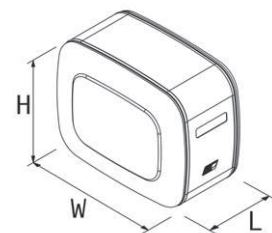

Products range	L*	Features included	Dimensions (only tank) L x H x W	Material	Product code NSGA: Aluminium NSGF: Painted steel NSGI: Stainless steel	Mounting kit code SIDE
50/64 diesel	90		350 x 500 x 640	A/F/I	- 0090035C100	Included
	280	- fuel cap with key and breathing valve	1000 x 500 x 640		- 0300100C100	
	350	- bayonet connection (for VDO level indicator)	1250 x 500 x 640		- 0380125C100	
	425	- diesel drainage	1500 x 500 x 640		- 0400150C100	
	450	- homologation ECE34 Part III (side installation)	1600 x 500 x 640		- 0500160C100	
	520		1800 x 500 x 640		- 0550180C100	
	570		2000 x 500 x 640		- 0600200C100	

* Full tank capacity

Accessories pp 38-39



64/50 (sidewalls 640 mm h x 500 mm w)**

Mounting kit available:

SIDE

Materials available:

A	F	I
Aluminium	Painted Steel RAL 7021	Stainless Steel



Download specifics
www.padoan.it/documents/Padoan_DIESEL_64-50_EN.pdf

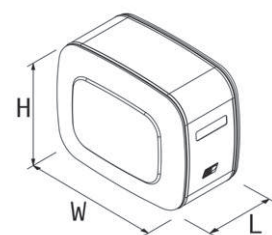

Products range	L*	Features included	Dimensions (only tank) L x H x W	Material	Product code NSGA: Aluminium NSGF: Painted steel NSGI: Stainless steel	Mounting kit code SIDE
64/50 diesel	90		350 x 640 x 500	A/F/I	- 0090035C1RV	Included
	280	- fuel cap with key and breathing valve	1000 x 640 x 500		- 0280100C1RV	
	350	- bayonet connection (for VDO level indicator)	1250 x 640 x 500		- 0350125C1RV	
	425	- diesel drainage	1500 x 640 x 500		- 0425150C1RV	
	450	- homologation ECE34 Part III (side installation)	1600 x 640 x 500		- 0450160C1RV	
	520		1800 x 640 x 500		- 0520180C1RV	
	570		2000 x 640 x 500		0600200C1RV	

* Full tank capacity ** Upon request

Accessories pp 38-39



63/70 (sidewalls 636 mm h x 706 mm w)



Mounting kit available:

SIDE

Download specifics
www.padoan.it/documents/Padoan_DIESEL_63-70_EN.pdf

Materials available:



Aluminium

Painted Steel
RAL 7021

Stainless Steel

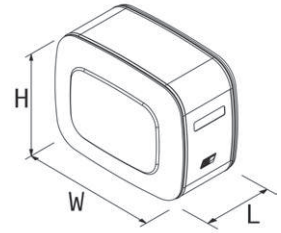

Products range	L*	Features included	Dimensions (only tank) L x H x W	Material	Product code NSGA: Aluminium NSGF: Painted steel NSGI: Stainless steel	Mounting kit code SIDE
63/70 diesel	110	<ul style="list-style-type: none"> - fuel cap with key and breathing valve - bayonet connection (for VDO level indicator) - diesel drainage - homologation ECE34 Part III (side installation) 	300 x 636 x 706	A/F/I	- 0120030C100	Included
	135		350 x 636 x 706		- 0135035C100	
	200		500 x 636 x 706		- 0200050C100	
	240		610 x 636 x 706		- 0250061C100	
	290		735 x 636 x 706		- 0300073C100	
	360		900 x 636 x 706		- 0350090C100	
	400		1000 x 636 x 706		- 0400100C100	
	450		1110 x 636 x 706		- 0450111C100	
	500		1250 x 636 x 706		- 0500125C100	
	550		1360 x 636 x 706		- 0550136C100	
	600		1500 x 636 x 706		- 0600150C100	
	650		1610 x 636 x 706		- 0650161C100	
	670		1700 x 636 x 706		- 0670170C100	
	730		1800 x 636 x 706		- 0700180C100	
815	2000 x 636 x 706	- 0800200C100				

* Full tank capacity

Accessories pp 38-39



70/63 (sidewalls 706 mm h x 636 mm w)**



Mounting kit available for:



Download specifics
www.padoan.it/documents/Padoan_DIESEL_70-63_EN.pdf

Materials available:

- A
 - F
 - I
- Aluminium Painted Steel RAL 7021 Stainless Steel

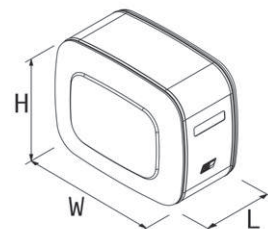

Products range	L*	Features included	Dimensions (only tank) L x H x W	Material	Product code NSGA: Aluminium NSGF: Painted steel NSGI: Stainless steel	Mounting kit code SIDE
70/63 diesel	110	<ul style="list-style-type: none"> - fuel cap with key and breathing valve - bayonet connection (for VDO level indicator) - diesel drainage - homologation ECE34 Part III (side installation) 	300 x 706 x 636	A/F/I	- 0110030C1RV	Included
	135		350 x 706 x 636		- 0135035C1RV	
	200		500 x 706 x 636		- 0200050C1RV	
	240		610 x 706 x 636		- 0240061C1RV	
	290		735 x 706 x 636		- 0290073C1RV	
	360		900 x 706 x 636		- 0360090C1RV	
	400		1000 x 706 x 636		- 0400100C1RV	
	450		1110 x 706 x 636		- 0450111C1RV	
	500		1250 x 706 x 636		- 0500125C1RV	
	550		1360 x 706 x 636		- 0550136C1RV	
	600		1500 x 706 x 636		- 0600150C1RV	
	650		1610 x 706 x 636		- 0650161C1RV	
	670		1700 x 706 x 636		- 0670170C1RV	
	730		1800 x 706 x 636		- 0730180C1RV	
815	2000 x 706 x 636	- 0800200C1RV				

* Full tank capacity ** Upon request



70/70 (sidewalls 700 mm h x 700 mm w)



Mounting kit available for:

SIDE

Download specifics
www.padoan.it/documents/Padoan_DIESEL_70-70_EN.pdf

Materials available:

A

F

Aluminium Painted
 Steel
 RAL 7021

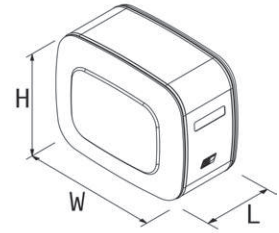

Products range	L*	Features included	Dimensions (only tank) L x H x W	Material	Product code	Mounting kit code
					NSGA: Aluminium NSGF: Painted steel	
70/70 diesel	125	<ul style="list-style-type: none"> - fuel cap with key and safety valve - bayonet connection for VDO level indicator) - diesel drainage - homologation ECE34 Part III (side installation) 	300 x 700 x 700	A/F	- 0140030C100	SIDE Included
	160		350 x 700 x 700		- 0160035C100	
	170		400 x 700 x 700		- 0190040C100	
	200		450 x 700 x 700		- 0200045C100	
	215		500 x 700 x 700		- 0230050C100	
	260		600 x 700 x 700		- 0280060C100	
	310		700 x 700 x 700		- 0330070C100	
	350		800 x 700 x 700		- 0370080C100	
	400		900 x 700 x 700		- 0400090C100	
	445		1000 x 700 x 700		- 0460100C100	
	500		1100 x 700 x 700		- 0500110C100	
	540		1200 x 700 x 700		- 0550120C100	
	590		1300 x 700 x 700		- 0600130C100	
	680		1500 x 700 x 700		- 0700150C100	
	815		1800 x 700 x 700		- 0800180C100	
910	2000 x 700 x 700	- 0900200C100				
960	2110 x 700 x 700	- 0960211C100				

* Full tank capacity

Accessories pp 38-39

Product images are for illustrative purposes only and might be different according to the actual product, accessories and mounting kit version



COMBINED TANKS

50/64 (sidewalls 500 mm h x 640 mm w)**



Download specifics
www.padoan.it/documents/Padoan_COMBINED_50-64_EN.pdf



Mounting kit available:



Materials available:

- A

Aluminium
- F

Painted Steel
RAL 7021
- I

Stainless Steel

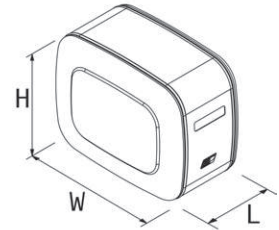

Products range	L* diesel / oil	Features included	Filter flange code (oil)	Dimensions (only tank) L x H x W	Material	Product code NSMA: Aluminium NSMF: Painted steel NSMI: Stainless steel	Mounting kit code SIDE
50/64 combined Multi Function (MF)	160/120	diesel - fuel cap with key and breathing valve - bayonet connection (for VDO level indicator)	135	1000 x 500 x 640	A/F/I	- 0160100C100	Included
	175/105	- diesel drainage - homologation ECE34 Part III (side installation)				- 0175100C100	
	190/90	oil - spy eye 1" - suction connection 1" 1/2 - air breather cap h 41mm - adjustable ball valve 1" 1/2				- 0191100C100	

* Full tank capacity ** Upon request

Accessories (oil partition) pp 34-36
 Accessories (diesel partition) pp 38-39

Product images are for illustrative purposes only and might be different according to the actual product, accessories and mounting kit version



64/50 (sidewalls 640 mm h x 500 mm w)



Download specifics
www.padoan.it/documents/Padoan_COMBINED_64-50_EN.pdf

Mounting kit available:



Materials available:

- A

Aluminium
- F

Painted Steel
RAL 7021
- I

Stainless Steel

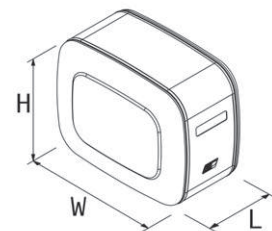

Products range	L* diesel / oil	Features included	Filter flange code (oil)	Dimensions (only tank) L x H x W	Material	Product code NSMA: Aluminium NSMF: Painted steel NSMI: Stainless steel	Mounting kit code SIDE
64/50 combined Multi Function (MF)	160/120	diesel - fuel cap with key and breathing valve - bayonet connection (for VDO level indicator)	135	1000 x 640 x 500	A/F/I	- 0160100C1RV	Included
	175/105	- diesel drainage - homologation ECE34 Part III (side installation)				- 0175100C1RV	
	190/90	oil - spy eye 1" - suction connection 1" 1/2 - air breather cap h 41mm - adjustable ball valve 1" 1/2				- 0191100C1RV	

* Full tank capacity

Accessories (oil partition) pp 34-36
 Accessories (diesel partition) pp 38-39

63/70 (sidewalls 636 mm h x 706 mm w)



Mounting kit available:

SIDE

Download specifics
www.padoan.it/documents/Padoan_COMBINED_63-70_EN.pdf

Materials available:

- A

Aluminium
- F

Painted Steel
RAL 7021
- I

Stainless Steel

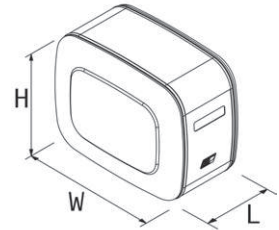

Products range	L* diesel / oil	Features included	Filter flange code (oil)	Dimensions (only tank) L x H x W	Material	Product code NSMA: Aluminium NSMF: Painted steel NSMI: Stainless steel	Mounting kit code SIDE
63/70 combined Multi Function (MF)	125/140	diesel - fuel cap with key and breathing valve - bayonet connection (for VDO level indicator)	135	700 x 636 x 706	A/F/I	- 0125070C100	Included
	140/170			800 x 636 x 706		- 0140080C100	
	160/150			800 x 636 x 706		- 0160080C100	
	180/170	900 x 636 x 706		- 0180090C100			
	190/200	1000 x 636 x 706		- 0190100C100			
	200/150	900 x 636 x 706		- 0200091C100			
	220/170	1000 x 636 x 706		- 0220100C100			
	280/200	1250 x 636 x 706		- 0280125C100			
	380/200	1500 x 636 x 706		- 0380150C100			
	410/170	1500 x 636 x 706		- 04100150C100			
	600/200	2000 x 636 x 706		- 0600200C100			

* Full tank capacity

Accessories (oil partition) pp 34-36
 Accessories (diesel partition) pp 38-39



70/70 (sidewalls 700 mm h x 700 mm w)



Mounting kit available:



Materials available:

- A Aluminium
- F Painted Steel RAL 7021

Download specifics
www.padoan.it/documents/Padoan_COMBINED_70-70_EN.pdf

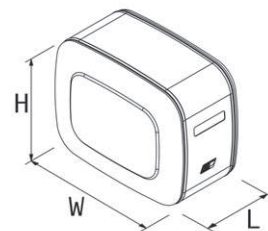

Products range	L* diesel / oil	Features included	Filter flange code (oil)	Dimensions (only tank) L x H x W	Material	Product code NSMA: Aluminium NSMF: Painted steel	Mounting kit code SIDE
70/70 combined Multi Function (MF)	150/150	diesel - fuel cap with key and breathing valve - bayonet connection (for VDO level indicator) - diesel drainage - homologation ECE34 Part III (side installation) oil - spy eye 1" - suction connection 1" 1/2 - air breather cap h 41mm - adjustable ball valve 1" 1/2	135	700 x 700 x 700	A/F	- 0150070C100	Included
	200/150			800 x 700 x 700		- 0200080C100	
	200/200			900 x 700 x 700		- 0200090C100	
	220/170			900 x 700 x 700		- 0220090C100	
	280/170			1000 x 700 x 700		- 0280100C100	
	300/200			1100 x 700 x 700		- 0300110C100	
	340/200			1200 x 700 x 700		- 0340120C100	
	400/200			1300 x 700 x 700		- 0400130C100	
	480/200			1500 x 700 x 700		- 0480150C100	
	600/200			1800 x 700 x 700		- 0600180C100	
700/200	2000 x 700 x 700	- 0700200C100					

* Full tank capacity

Accessories (oil partition) pp 34-36
 Accessories (diesel partition) pp 38-39



ACCESSORIES OIL TANK

Semi-immersed Return Filters

for all tanks excluded 26/36, 36/26 and 70/70R



				Oil and combined tanks	
Filter Flange	l/min flow	Micron / µm	Inlet Connection	Product Code	Spare Parts Cartridge
135	250 l/min	40 µm microfibre	1"1/4	AFO0SEM136125CF	AFO0ELF205070CF
	200 l/min	21 µm microfibre	1"1/4	AFO0SEM136125F2	AFO0ELF205070F2
	150 l/min	10 µm paper	1"1/4	AFO0SEM136125C1	AFO0ELF205070C1
195	300 l/min	60 µm wire mesh	1"1/4	AFO0SEM195125CL	AFO0ELF210100RM
	250 l/min	21 µm microfibre	1"1/4	AFO0SEM195125F2	AFO0ELF211099F2
	250 l/min	10 µm paper	1"1/4	AFO0SEM19512510	AFO0ELF211099C1
195	300 l/min	60 µm wire mesh	1"1/4 + 3/4"	AFO0SEM195225CL	AFO0ELF210100RM
	250 l/min	21 µm microfibre	1"1/4 + 3/4"	AFO0SEM195225F2	AFO0ELF211099F2
	250 l/min	10 µm paper	1"1/4 + 3/4"	AFO0SEM19522510	AFO0ELF211099C1

only for 26/36 - 36/26 oil tanks

135	150 l/min	60 µm wire mesh	1"	AFO0SEM135100ST	AFO0ELF128070BF
	125 l/min	21 µm microfibre	1"	AFO0SEM135100F2	AFO0ELF13007025

* Immersed Return Filters for Easy Kit

for all tanks excluded 26/36, 36/26, 70/70R and monobrace



				Oil and combined tanks	
Filter Flange	l/min flow	Micron / µm	Inlet Connection	Product Code	Spare Parts Cartridge
135	250 l/min	40 µm microfibre	/	AFO0IMM090340CF	AFO0ELF205070CF
	200 l/min	21 µm microfibre	/	AFO0IMM090340F2	AFO0ELF205070F2
	150 l/min	10 µm paper	/	AFO0IMM090340C1	AFO0ELF205070C1

only for 26/36 - 36/26 oil tanks

135	150 l/min	60 µm wire mesh	1"	AFO0IMM090240RM	AFO0ELF142070RM
	125 l/min	21 µm microfibre	1"	AFO0IMM090240F2	AFO0ELF142070F2

* Customized valve plates are available on request according to your tipping valve hole layout.

Immersed Easy Filters

for all tanks excluded 26/36, 36/26, 70/70R and monobrace



				Oil and combined tanks	
Filter Flange	l/min flow	Micron / µm	Inlet Connection	Product Code	Spare Parts Cartridge
135	220 l/min	40 µm microfibre	1"	AFO0IMM134100CF	AFO0ELF205070CF
	180 l/min	21 µm microfibre	1"	AFO0IMM134100F2	AFO0ELF205070F2
	150 l/min	10 µm paper	1"	AFO0IMM134100C1	AFO0ELF205070C1

only for 26/36 - 36/26 oil tanks

135	150 l/min	60 µm wire mesh	1"	AFO0IMM134101ST	AFO0ELF142070RM
	125 l/min	21 µm microfibre	1"	AFO0IMM134101F2	AFO0ELF142070F2

In-line filters



			Oil and combined tanks	
l/min flow	Micron / µm	Inlet connection	Product Code	Spare Parts Cartridge
150 l/min	25 µm microfibre	1"	AFO0LIN000100F2	AFO0ELF177096F2
230 l/min	60 µm wire mesh	1" 1/4	AFO0LIN000100RM	AFO0ELF177096RM
170 l/min	25 µm microfibre	1"	AFO0LIN000125F2	AFO0ELF177096F2
270 l/min	60 µm wire mesh	1" 1/4	AFO0LIN000125RM	AFO0ELF177096RM

Filter's clogging visual indicator



			Oil and combined tanks	
Products Range	Description	Specifics	Product Code	Spare Parts
Oil tanks	Filter's clogging visual indicator	R 1/8" - EN 10226	AI10MPF195VSR42	/

Aluminium cover with return connection and pipe for all tanks with filter flange 135, monobacket excluded



			Oil and combined tanks	
Products Range	Description	Specifics	Product Code	Spare Parts
Oil tanks	Aluminium cover 160mm	1" return connection and pipe	ACFA1604F010027	/

Air breather caps



			Oil and combined tanks	
Products Range	Description	Specifics	Product Code	Spare Parts Cartridge
MF / Monobacket / Compact 75l - 90l / T20 / MFPG	Air breather cap with air filter, fixing screws and anti-splash	h 41 mm - air cartridge paper 10 µm	ATP0PLSCAR0L120	AFA0CARCILTOP20
RC / RC30	Air breather cap with air filter, fixing screws and anti-splash	h 69 mm - air cartridge paper 10 µm	ATP0PLSCAR0L110	AFA0CARCILTOP10

Level indicators



			Oil and combined tanks	
Products Range	Description	Specifics	Product Code	Spare Parts
MF / Monobacket / Compact / MFPG / Classic	round aluminium level gauge	1"	AILOROTLIQ100AL	/
26/36 / 36/26	round aluminium level gauge	3/4"	AILOROTLIQ075AL	/
MF (44/54 60-70lt)	sight level gauge	not graduated - 127 mm distance between centers (M12)	AILOVISLIQ12701	/
T20*	sight level gauge	not graduated - 254 mm distance between centers (M12)	AILOVISLIQ25400	/
		not graduated - 254 mm distance between centers (M12)- low level electric sensor, 2,5 mm wire connection	AILOVISLIQ254CE	/
		graduated - 254 mm distance between centers (M12) - with thermometer	AILOVISLIQ254TR	/

* not included in the standard tank

Product images are for illustrative purposes only and might be different according to the actual product, accessories and mounting kit version

Adjustable ball valves



			Oil and combined tanks		
Products Range	Description	Specifics	Product Code	Spare Parts	
Oil tanks	adjustable ball valve MF with lever	1" 1/4	ARU0ABV12500100	/	
	adjustable ball valve MF with lever	1" 1/2	ARU0ABV15000100	/	
	adjustable ball valve MF with lever	2"	ARU0ABV20000100	/	
	adjustable ball valve MF with lever	2" 1/2	ARU0ABV25000100	/	

Fits with 26/36 and 36/26 oil tanks

Oil Tanks	adjustable ball valve MF with lever	1" 1/4	ARU0ABV12500100
-----------	-------------------------------------	--------	-----------------

Pipe fittings



			Oil and combined tanks		
Products Range	Description	Specifics	Product Code	Spare Parts	
Oil tanks	Straight pipe fitting, Ø40mm hose, inox band and sealing	1" 1/4	ARA0PDNPGM12500	/	
	Straight pipe fitting, Ø50mm hose, inox band and sealing	1" 1/4	ARA0PDNPGM12000	/	
	Straight pipe fitting, Ø40mm hose, inox band and sealing	1" 1/2	ARA0PDNPGM15100	/	
	Straight pipe fitting, Ø50mm hose, inox band and sealing	1" 1/2	ARA0PDNPGM15000	/	
	Straight pipe fitting, Ø65mm hose, inox band and sealing	2"	ARA0PDNPGM20000	/	
	Straight pipe fitting, Ø64mm hose, inox band and sealing	2" 1/2	ARA0RR0PGM25000	/	
	Straight pipe fitting, Ø75mm hose, inox band and sealing	2" 1/2	ARA0RR0PGM25010	/	
	45° adjustable pipe fitting, Ø50mm hose, inox band and sealing	1" 1/4	ARA0PDNPGM12025	/	
	45° adjustable pipe fitting, Ø40mm hose, inox band and sealing	1" 1/4	ARA0PDNPGM12525	/	
	45° adjustable pipe fitting, Ø50mm hose, inox band and sealing	1" 1/2	ARA0PDNPGM15025	/	
	90° adjustable pipe fitting, Ø40mm hose, inox band and sealing	1" 1/4	ARA0PDNPGM12550	/	
	90° adjustable pipe fitting, Ø50mm hose, inox band and sealing	1" 1/4	ARA0PDNPGM12050	/	
	90° adjustable pipe fitting, Ø50mm hose, inox band and sealing	1" 1/2	ARA0PDNPGM15050	/	
	90° adjustable pipe fitting, Ø65mm hose, inox band and sealing	2"	ARA0PDNPGM20050	/	

Adjustable fittings



			Oil and combined tanks		
Products Range	Description	Specifics	Product Code	Spare Parts	
Oil tanks	90° adjustable fitting M/F	1" 1/4	ARA0PDNFLT12550	/	
	90° adjustable fitting M/F	1" 1/2	ARA0PDNFLT15050	/	
	90° adjustable fitting M/F	2" 1/2	ARA0PDNFLT25050	/	

Download specifics



https://www.padoan.it/documents/Padoan_DIESEL_Accessories_EN.pdf

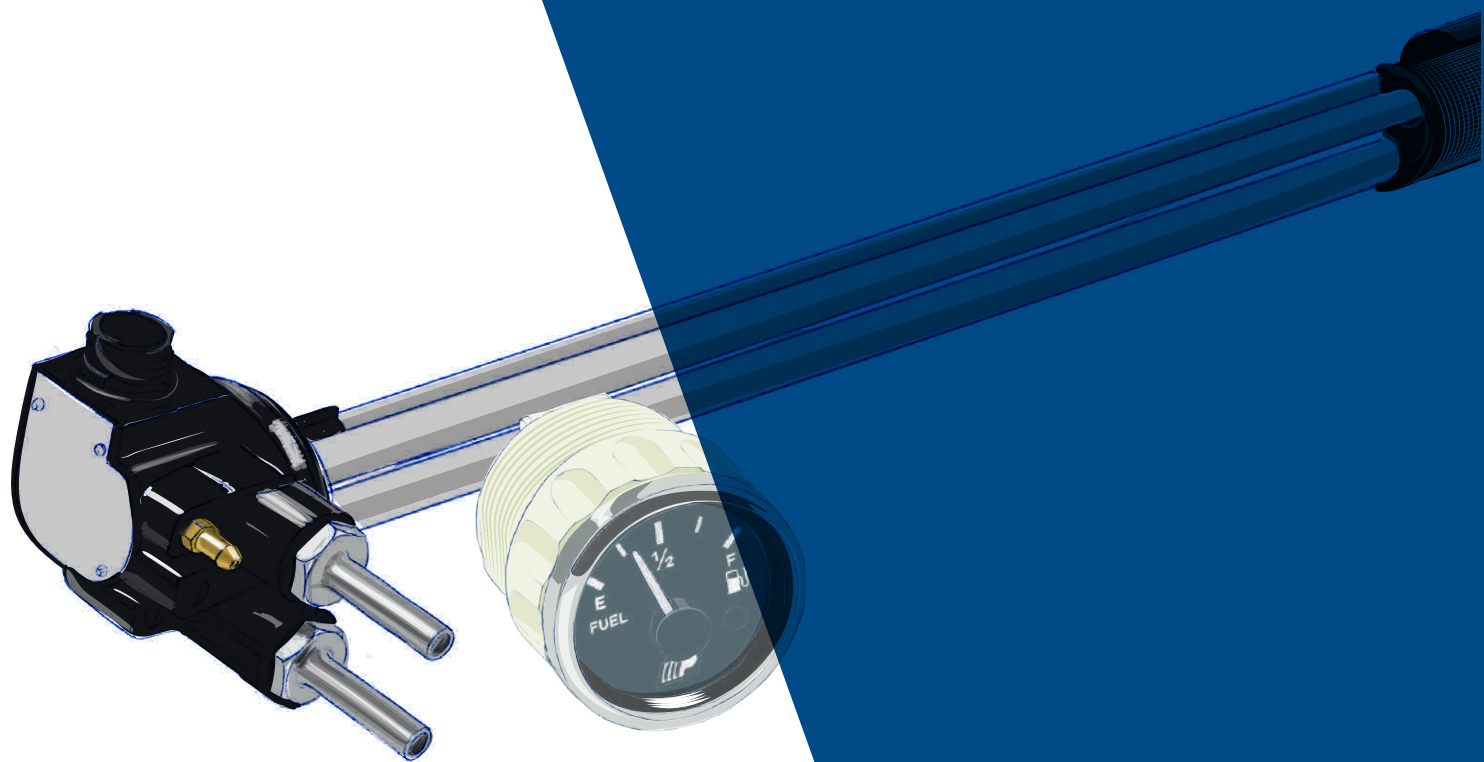

ACCESSORIES DIESEL TANK

Diesel level indicators (for Padoan tanks)

Diesel oil and combined tanks



Products Range	Description	Specifics	Product Code	Spare Parts
Diesel oil tanks	Diesel level indicator 250 mm length	Suction and return 10mm, bayonet connection, 4PIN socket connector with switch low level connection	AIC0GENVD025030	/
	Diesel level indicator 430 mm length	Suction and return 10mm, bayonet connection, 4PIN socket connector with switch low level connection	AIC0GENVD043030	/
	Diesel level indicator 490 mm length	Suction and return 10mm, bayonet connection, 4PIN socket connector with switch low level connection	AIC0GENVD049030	/
	Diesel level indicator 620 mm length	Suction and return 10mm, bayonet connection, 4PIN socket connector with switch low level connection	AIC0GENVD062030	/
	Diesel level indicator 690 mm length	Suction and return 10mm, bayonet connection, 4PIN socket connector with switch low level connection	AIC0GENVD069030	/

Analogue cabin diesel oil indicator
(to be installed with the generic level oil indicator and Padoan tanks)

Diesel oil and combined tanks



Products Range	Description	Specifics	Product Code	Spare Parts
Diesel oil tanks	Cabin fuel level indicator (to be installed with Padoan tank and diesel level indicator)	Round screen with reserve signal	AILOGENPDN00000	/

Diesel connection kits

Diesel oil and combined tanks



Products Range	Description	Specifics	Product Code	Spare Parts
Diesel oil tanks	Connection kit for diesel tank Pipe length 1.500 mm	no. 2 3/4" elbows, no. 2 3/4" valves, no. 2 rubber holders with length 12 mm, no. 1 pipe with 12 mm diameter and 1.500 mm length	AKA0ABBGAS07500	/
	Connection kit for diesel tank Pipe length 3.000 mm	no. 2 3/4" elbows, no. 2 3/4" valves, no. 2 rubber holders with length 12 mm, no. 1 pipe with 12 mm diameter and 3.000 mm length	AKA0ABBGAS07501	/

**Fuel caps
included**

Diesel oil and combined tanks

	Products Range	Description	Specifics	Product Code	Spare Parts
	Diesel oil tanks	Fuel Cap, diameter 80 mm, with bayonet connection	with key and safety valve - plastic	ATP0CARCARB80CE	/

VDO Cap

Diesel oil and combined tanks

	Products Range	Description	Specifics	Product Code	Spare Parts
	Diesel oil tanks	Cap with bayonet connection	equipped with cover and rubber	ATP0COPATTVDOPC	/

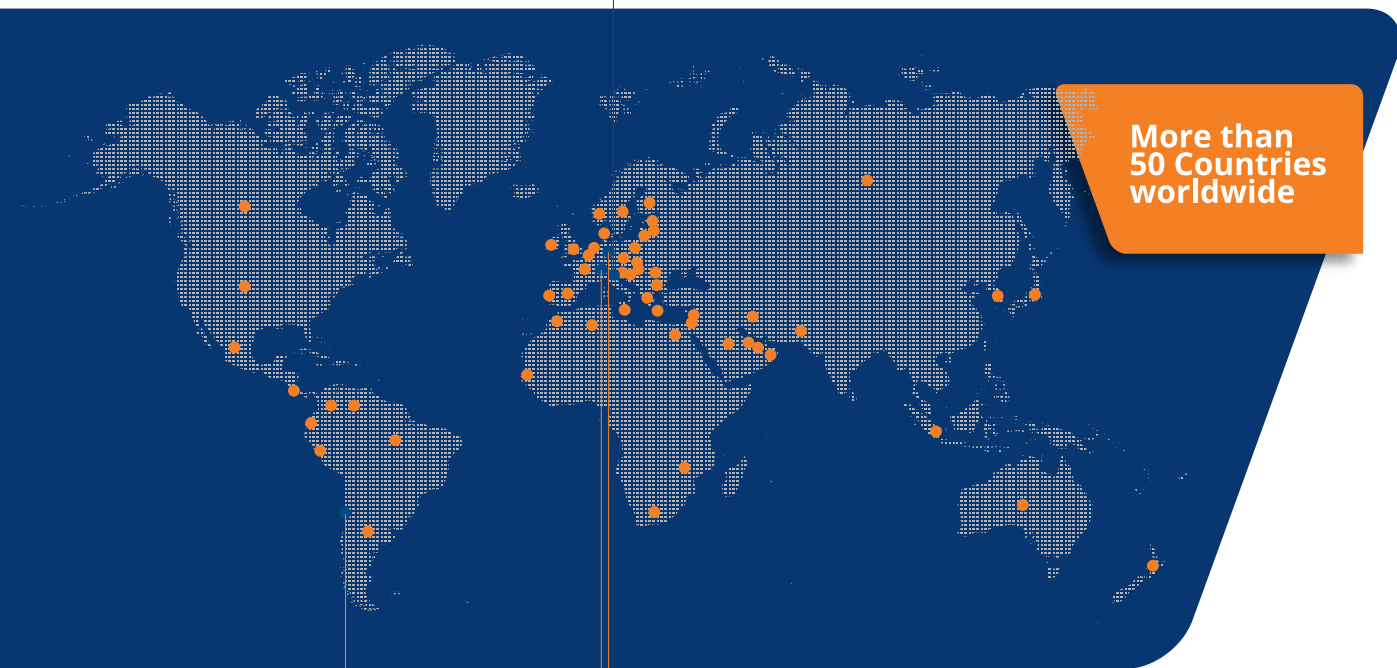

More than 50 Countries worldwide



Padoan Srl
Via Risorgive, 20
31048 Olmi di S. Biagio di Callalta (TV) - Italy
ph. +39 0422 362172
info@padoan.it - www.padoan.it

Padoan Swiss SA
San Vittore, Cantone Grigioni - Switzerland

Padoan Deutschland GmbH
Mönchengladbach - Germany

Padoan Chile da
Santiago - Chile

